

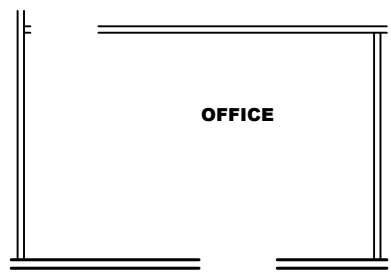

**Model # 34M213** Minimum Joist Spacing 16"  
 Box Width = 158" Double wide No Offset Box  
 Box Length = 56 ft. 99.5" 10" MIN I-BEAM No Clerestory  
 No Skylights No Origami Dormer  
 No Porches No Sunken Floor  
 Joist Size = #2 spf 2x6 Lags 9Mx3" No Parapet Roof

**Version R13.20**

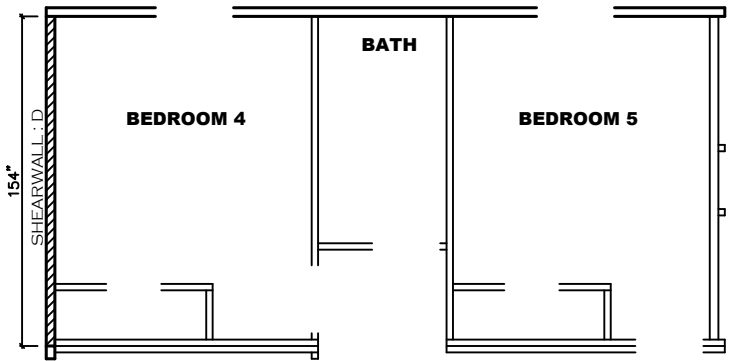

**OPTIONAL OFFICE  
REPLACES BEDROOM 2**

Wind Zone 1 Standard Roof						(3/8" sheathing only with 15 gax 1.5" at 5'10" oc (197 plf) Chords: 2x4 SPF Stud Top Plate & 1x3 SPF Rail. Each spliced w/2x4 MCP.	96 inch sidewall
Shearwall	Dist. / Hitch	Length	PLF	# of Joists	Lags	Notes	
A	0'	88"	162	2	1/1		
B	0'	88"	162	2	1/1		
C	76'	88"	162	2	1/1		
D	76'	88"	162	2	1/1		

Wind Zone 2 Standard Roof						(3/8" & ceiling with 15 gax 1.5" at 5'10" oc. (267 plf) Chords: 2x4 SPF #3 Top Plate spliced w/ 2.5x6 MCP & 2x4 SPF #3 Rail spliced w/ 12" glue block.	96 inch sidewall
Shearwall	Dist. / Hitch	Length	PLF	# of Joists	Lags	Notes	
A	0'	Full	425	2	4/4		
B	0'	Full	425	2	4/4		
C	76'	Full	425	2	4/4		
D	76'	Full	425	2	4/4		

Wind Zone 1 15:12 Roof						(3/8" & ceiling with 15 gax 1.5" at 5'10" oc. (267 plf) Chords: 2x4 SPF #3 Top Plate & 2x4 Rail. Each spliced w/12" glue block.	96 inch sidewall
Shearwall	Dist. / Hitch	Length	PLF	# of Joists	Lags	Notes	
A	0'	Full	425	2	4/4		
B	0'	Full	425	2	4/4		
C	76'	Full	425	2	4/4		
D	76'	Full	425	2	4/4		

Wind Zone 3 Standard Roof						(3/8" sheathing only w/ 12" oc (300) unblocked & (347) blocked Chords: 2x4 SPF #3 Top Plate spliced w/ 3x6 MCP & 2x6 SPF #3 Rail spliced w/ 12" glue block.	96 inch sidewall Block Dist. X=0'
Shearwall	Dist. / Hitch	Length	PLF	# of Joists	Lags	Notes	
A	0'	Full	425	2	4/4		
B	0'	Full	425	2	4/4		
C	76'	Full	425	2	4/4		
D	76'	Full	425	2	4/4		



SHEET: <b>ZONE</b>	<b>SHEARWALL PLAN</b>	Clayton - 934 1420 Mountain Rd, Andersonville, TN 37705 PH: 865.494.7800 FAX: 865.494.0243	DRAWING #:	34M213	MODEL:	THE EAGLE 76 (28'x76')	STD PLAN "CONDITIONED":	2,001 FT <sup>2</sup>
			MODEL #:	EGL28765A	SERIES:	EAGLE SERIES	REV. BY:	
			DATE:	05/08/2023	SCALE:	N.T.S.	PRODUCT DESIGNER:	DANIEL C. SHELDON

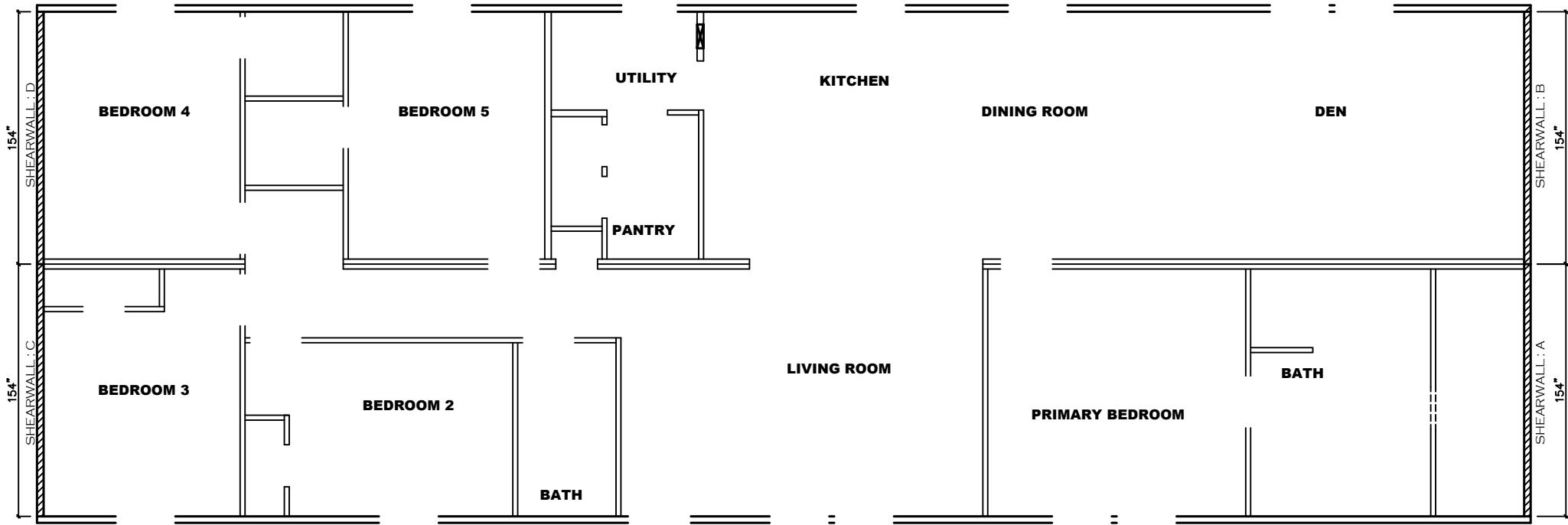

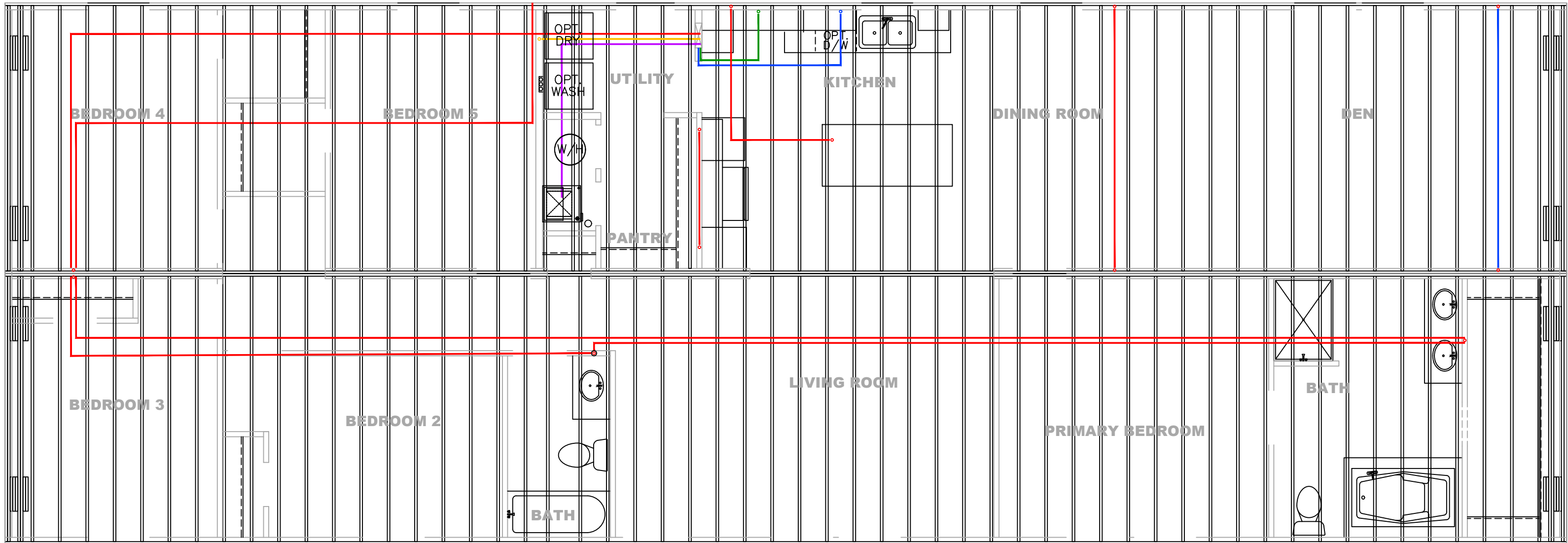
- = GFI (12-2)
- = RANGE
- = FURNACE
- = DRYER
- = WATER HEATER
- = DISHWASHER (D/W)
- = REFRIGERATOR
- MC = METER CENTER DROP

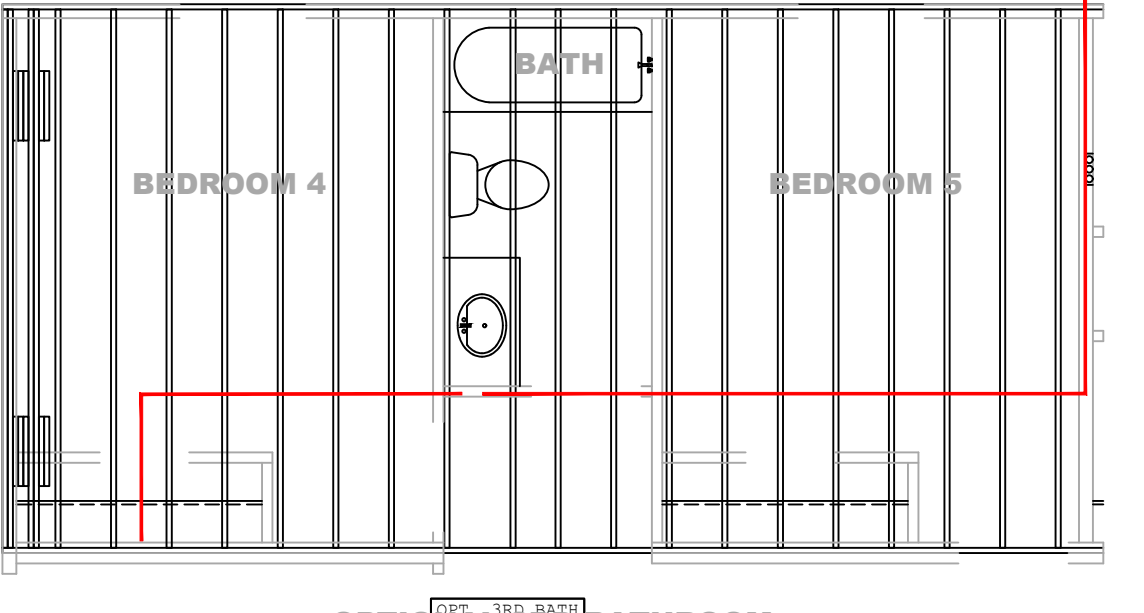

REVISION	DATE	DESCRIPTION

SHEET:  
FJIG ELEC

FLOOR JOIST  
ELECTRICAL LAYOUT

**Clayton** Clayton - 934  
1420 Mountain Rd, Andersonville, TN 37705  
PH: 865.494.7800 FAX: 865.494.0243

HILBORN, WERNER, CARTER,  
AND ASSOCIATES, INC.  
1627 SOUTH MYRTLE AVE.  
CLEARWATER, FL. 33756

DRAWING # 34M213  
MODEL # EGL28765A  
DATE: 07/05/2023

SCALE: N.T.S.

MODEL: THE EAGLE 76 (28'x76')  
SERIES: EAGLE SERIES  
PRODUCT DESIGNER: BRIAN K. RIFFEY

STD PLAN "CONDITIONED": 2,001 FT<sup>2</sup>  
REV. BY:  
REV. DATE:

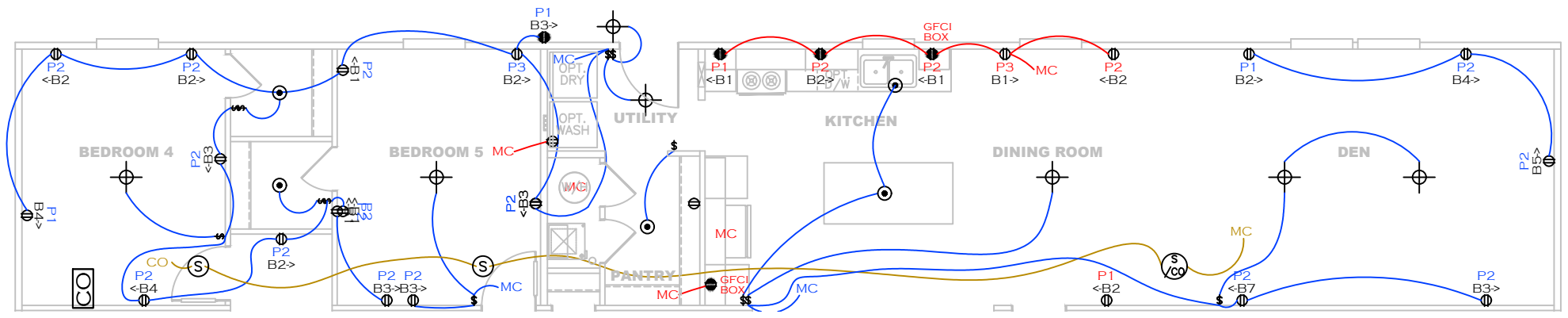

- = 14-2 WIRE (BLUE)
- = 14-2 WIRE (GREEN/LIGHTS)
- = 14-2 WIRE (ORANGE/LED)
- = 12-2 WIRE (RED)
- = 14-3 WIRE (BROWN)
- = THERMOSTAT (LIGHT GREEN)
- CO = CROSSOVER
- MC = METER CENTER DROP

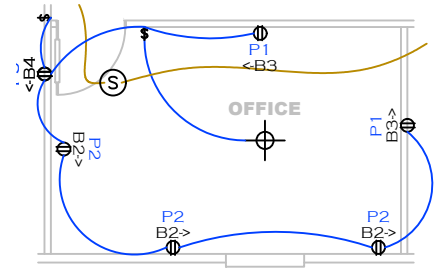
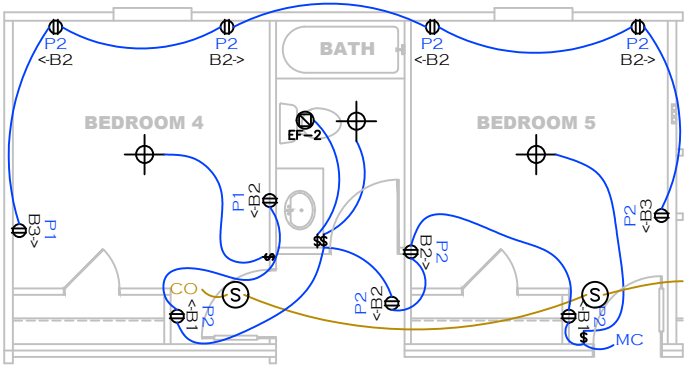

- = STANDARD LIGHT
- = CAN LIGHT
- = SMOKE DETECTOR
- = 50 CFM FAN
- = 100 CFM FAN

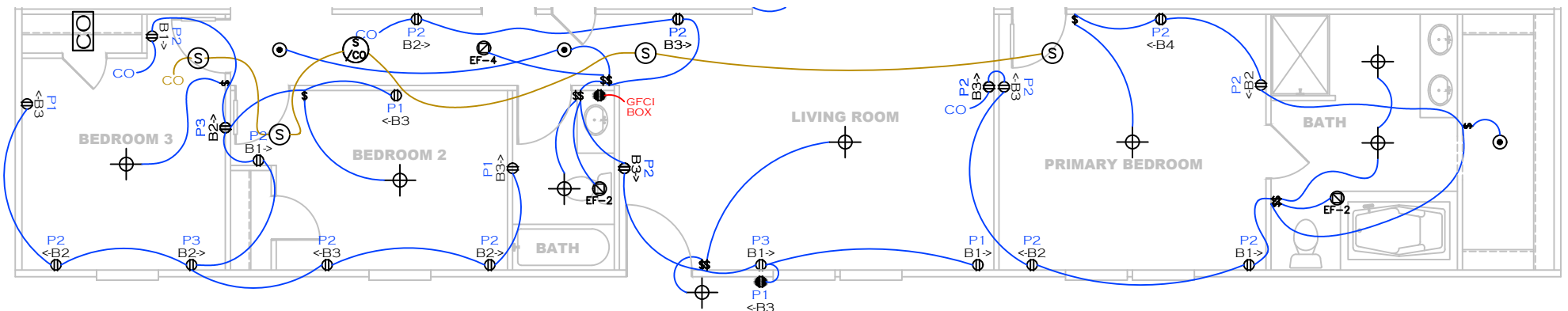

SHEET: MASTER	WIRE RUN PLAN	Clayton - 934 1420 Mountain Rd, Andersonville, TN 37705 PH: 865.494.7800 FAX: 865.494.0243	HILBORN, WERNER, CARTER, AND ASSOCIATES, INC. 1627 SOUTH MYRTLE AVE. CLEARWATER, FL. 33756	DRAWING # 34M176	MODEL: THE EAGLE 76 (28'x76')	STD PLAN "CONDITIONED": 2,001 FT <sup>2</sup>
				MODEL # EGL28765A	SERIES: EAGLE SERIES	REV. BY: DCS
			DATE: 02/05/2020	SCALE: N.T.S.	PRODUCT DESIGNER: DANIEL C. SHELDON	REV. DATE: 02/10/2021

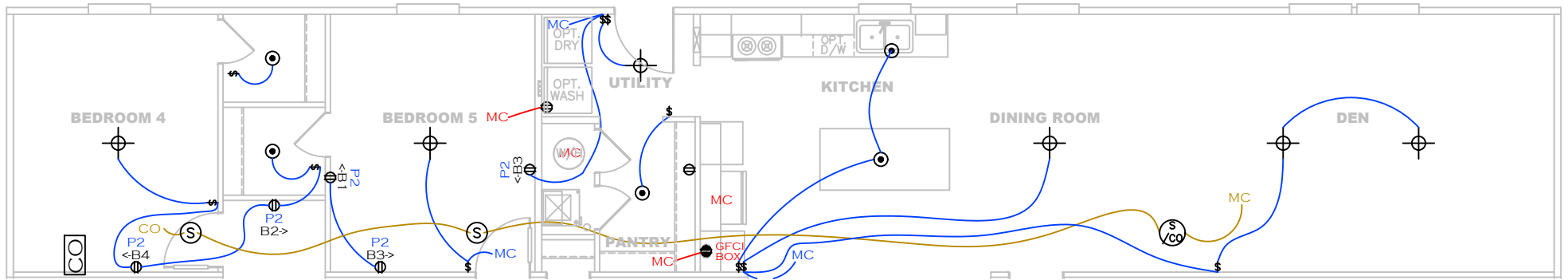

- = 14-2 WIRE (BLUE)
- = 14-2 WIRE (GREEN/LIGHTS)
- = 14-2 WIRE (ORANGE/LED)
- = 12-2 WIRE (RED)
- = 14-3 WIRE (BROWN)
- = THERMOSTAT (LIGHT GREEN)
- CO = CROSSOVER
- MC = METER CENTER DROP

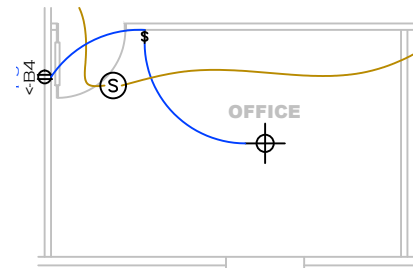
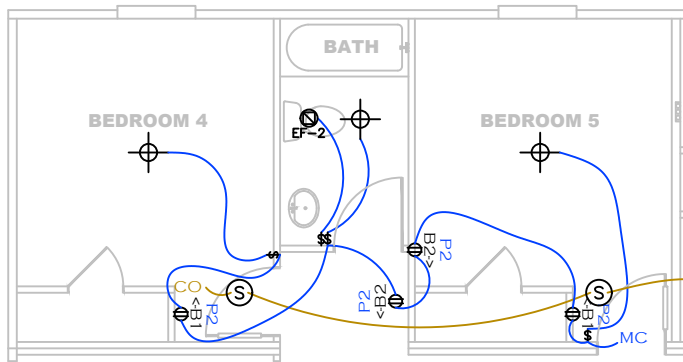

- = STANDARD LIGHT
- = CAN LIGHT
- = SMOKE DETECTOR
- = 50 CFM FAN
- = 100 CFM FAN

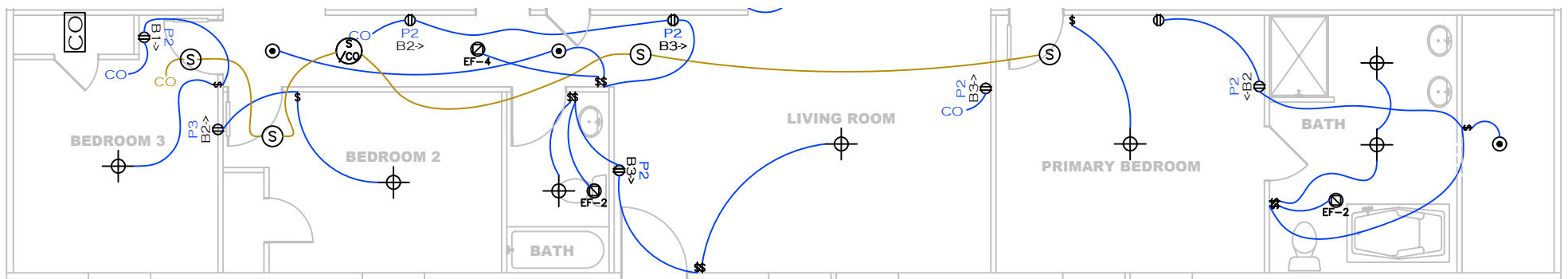

SHEET:  
TOP

WIRE RUN PLAN

**Clayton** Clayton - 934  
1420 Mountain Rd, Andersonville, TN 37705  
PH: 865.494.7800 FAX: 865.494.0243

HILBORN, WERNER, CARTER,  
AND ASSOCIATES, INC.  
1627 SOUTH MYRTLE AVE.  
CLEARWATER, FL. 33756

DRAWING # 34M213  
MODEL # EGL28765A  
DATE: 07/05/2023 SCALE: N.T.S.

MODEL: THE EAGLE 76 (28'x76')  
SERIES: EAGLE SERIES  
PRODUCT DESIGNER: BRIAN K. RIFFEY

STD PLAN "CONDITIONED": 2,001 FT<sup>2</sup>  
REV. BY:  
REV. DATE:

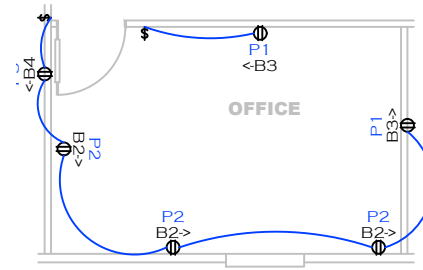
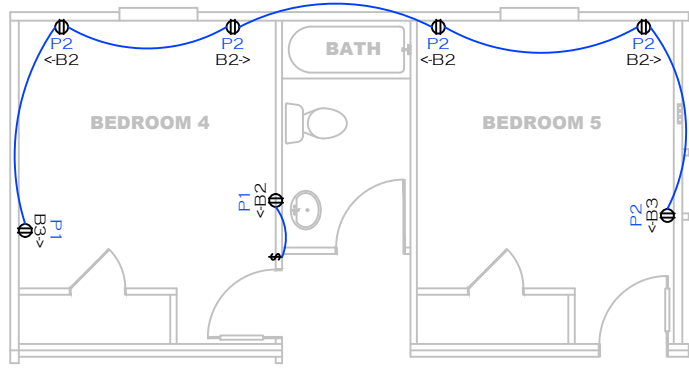
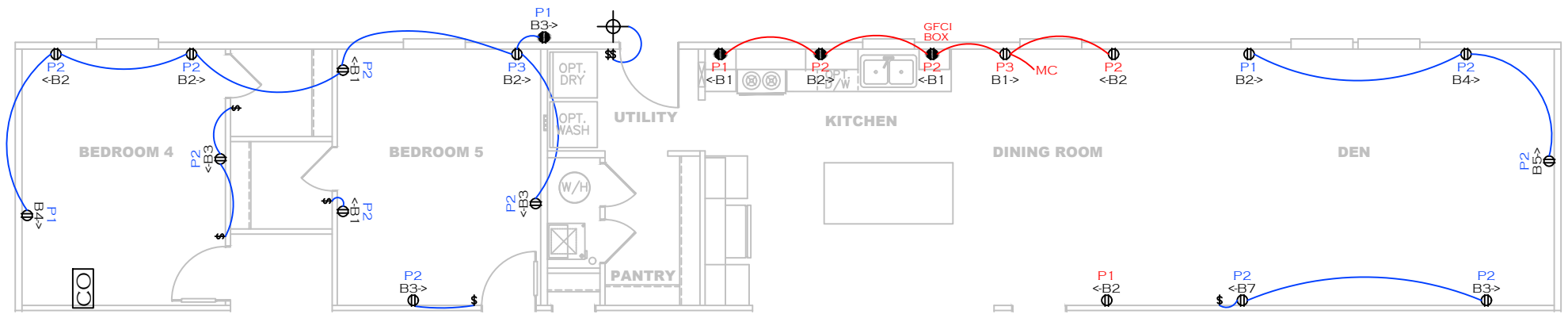

- = 14-2 WIRE (BLUE)
- = 14-2 WIRE (GREEN/LIGHTS)
- = 14-2 WIRE (ORANGE/LED)
- = 12-2 WIRE (RED)
- = 14-3 WIRE (BROWN)
- = THERMOSTAT (LIGHT GREEN)
- CO = CROSSOVER
- MC = METER CENTER DROP

- = STANDARD LIGHT
- = CAN LIGHT
- = SMOKE DETECTOR
- = 50 CFM FAN
- = 100 CFM FAN

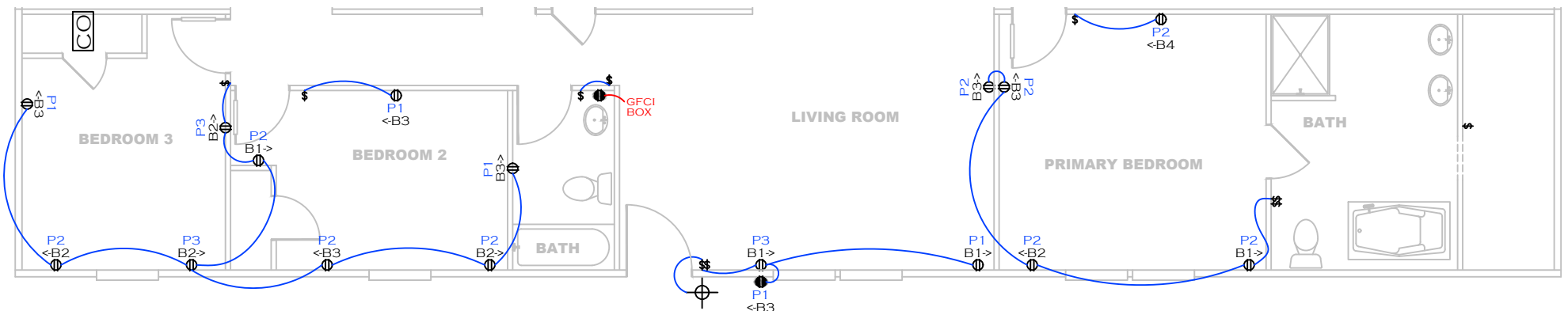

SHEET: <b>BOTTOM</b>	<b>WIRE RUN PLAN</b>	Clayton - 934 1420 Mountain Rd, Andersonville, TN 37705 PH: 865.494.7800 FAX: 865.494.0243	DRAWING # 34M176	MODEL: THE EAGLE 76 (28'x76')	STD PLAN "CONDITIONED": 2,001 FT <sup>2</sup>
			MODEL # EGL28765A	SERIES: EAGLE SERIES	REV. BY: DCS
			DATE: 02/05/2020	SCALE: N.T.S.	PRODUCT DESIGNER: DANIEL C. SHELDON

HILBORN, WERNER, CARTER,  
AND ASSOCIATES, INC.  
1627 SOUTH MYRTLE AVE.  
CLEARWATER, FL. 33756

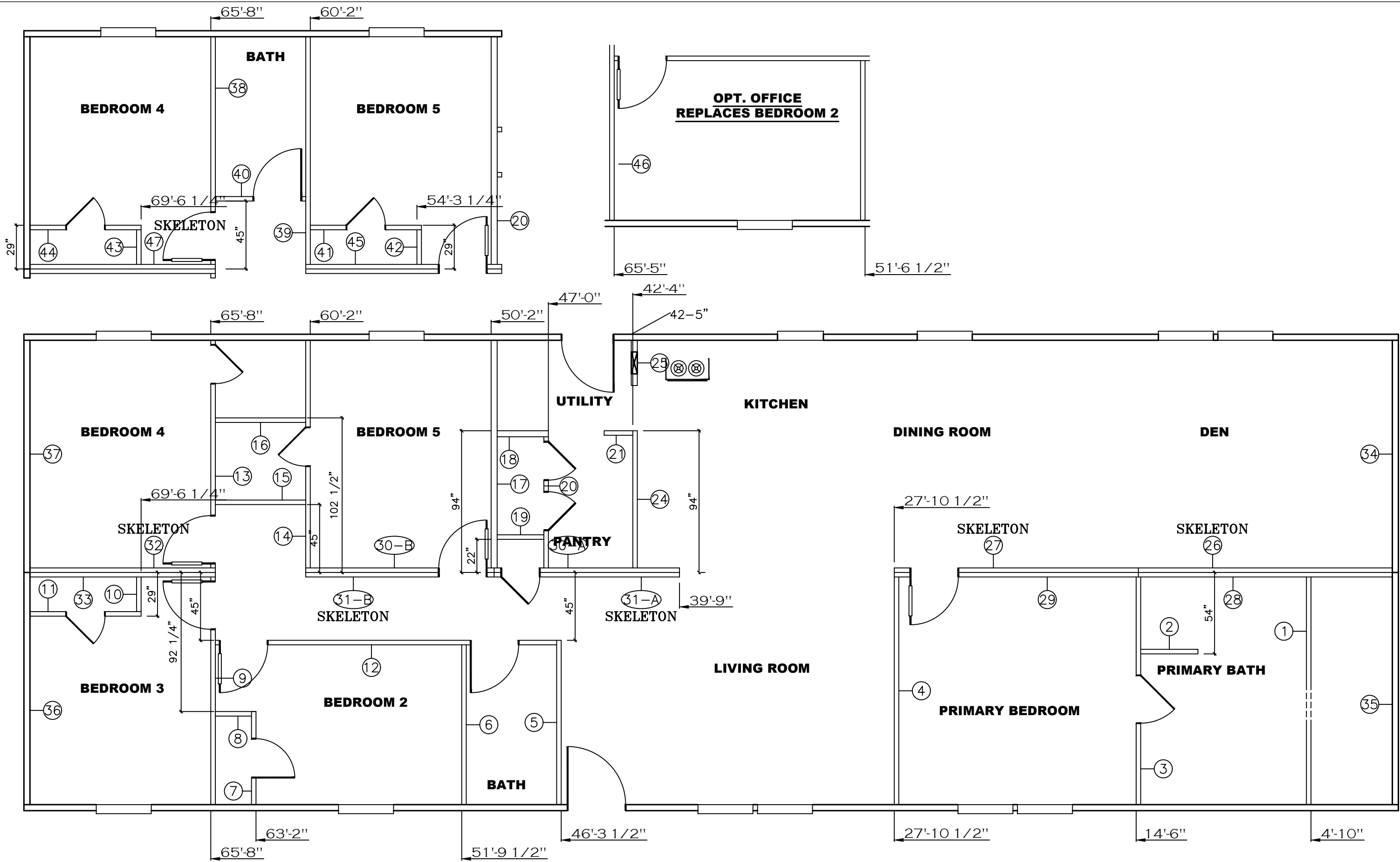

REVISION	DATE	DESCRIPTION	REVISION	DATE	DESCRIPTION

SHEET:  
BASE

WALL SET PLAN

**Clayton** Clayton - 934  
1420 Mountain Rd, Andersonville, TN 37705  
PH: 865.494.7800 FAX: 865.494.0243

HILBORN, WERNER, CARTER,  
AND ASSOCIATES, INC.  
1627 SOUTH MYRTLE AVE.  
CLEARWATER, FL. 33756

DRAWING # 34M213  
MODEL # EGL28765A  
DATE: 07/05/2023 SCALE: N.T.S.

MODEL: THE EAGLE 76 (28'x76")  
SERIES: EAGLE SERIES  
PRODUCT DESIGNER: BRIAN K. RIFFEY

STD PLAN "CONDITIONED":  
2,001 FT<sup>2</sup>  
REV. BY:  
REV. DATE:

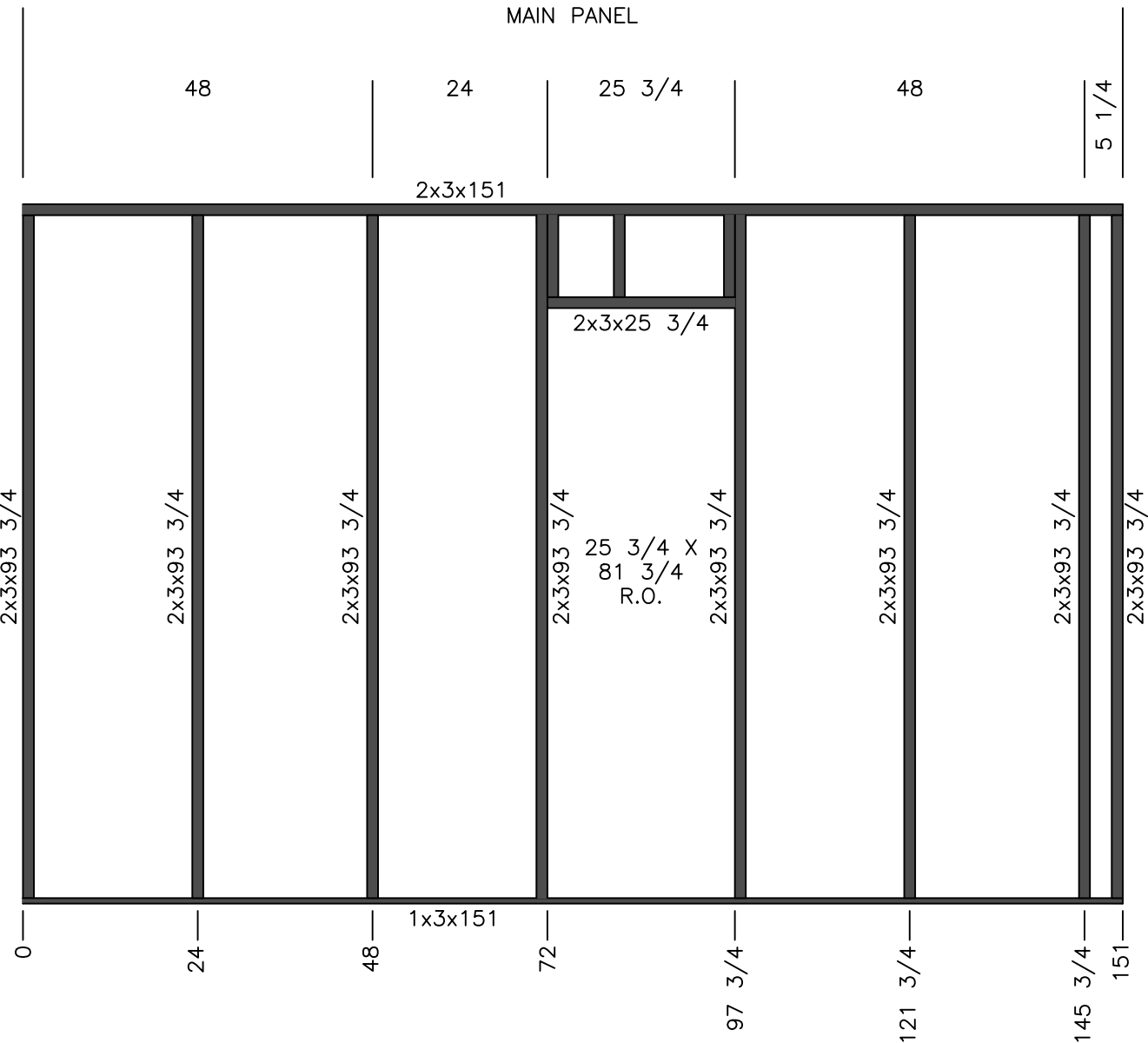

CUTLIST		
QTY	SIZE	TYPE
1	151	1x3
1	151	2x3
8	93 3/4	2x3
1	25 3/4	2x3
3	11 1/4	2x3

REFERENCE: WALL SET PRINT 34M176 BASE

 Appalachia - 934	MODEL #: EGL28765A	DRAWING #: 34M176
	DATE: 01/07/2020 SCALE: N.T.S.	
PRODUCT DESIGNER: D.C.S.	MODEL: 28' x 76' Eagle	
DESC: WALL 1		REV:

STUD SPACING 24"



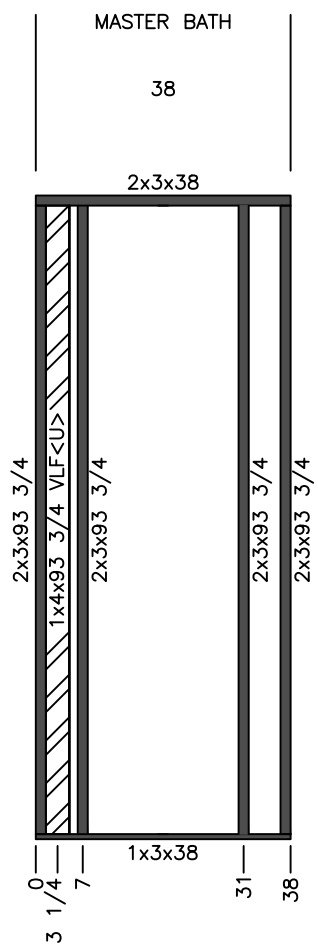

CUTLIST		
QTY	SIZE	TYPE
1	38	1x3
1	38	2x3
4	93 3/4	2x3
1	93 3/4 VLF<U>	1x4

REFERENCE: WALL SET PRINT 34M176 BASE

 Appalachia - 934	MODEL #: EGL28765A	DRAWING #: 34M176
	DATE: 01/07/2020	
PRODUCT DESIGNER: D.C.S.	MODEL: 28' x 76' Eagle	
DESC: WALL 2	REV:	

STUD SPACING 24"

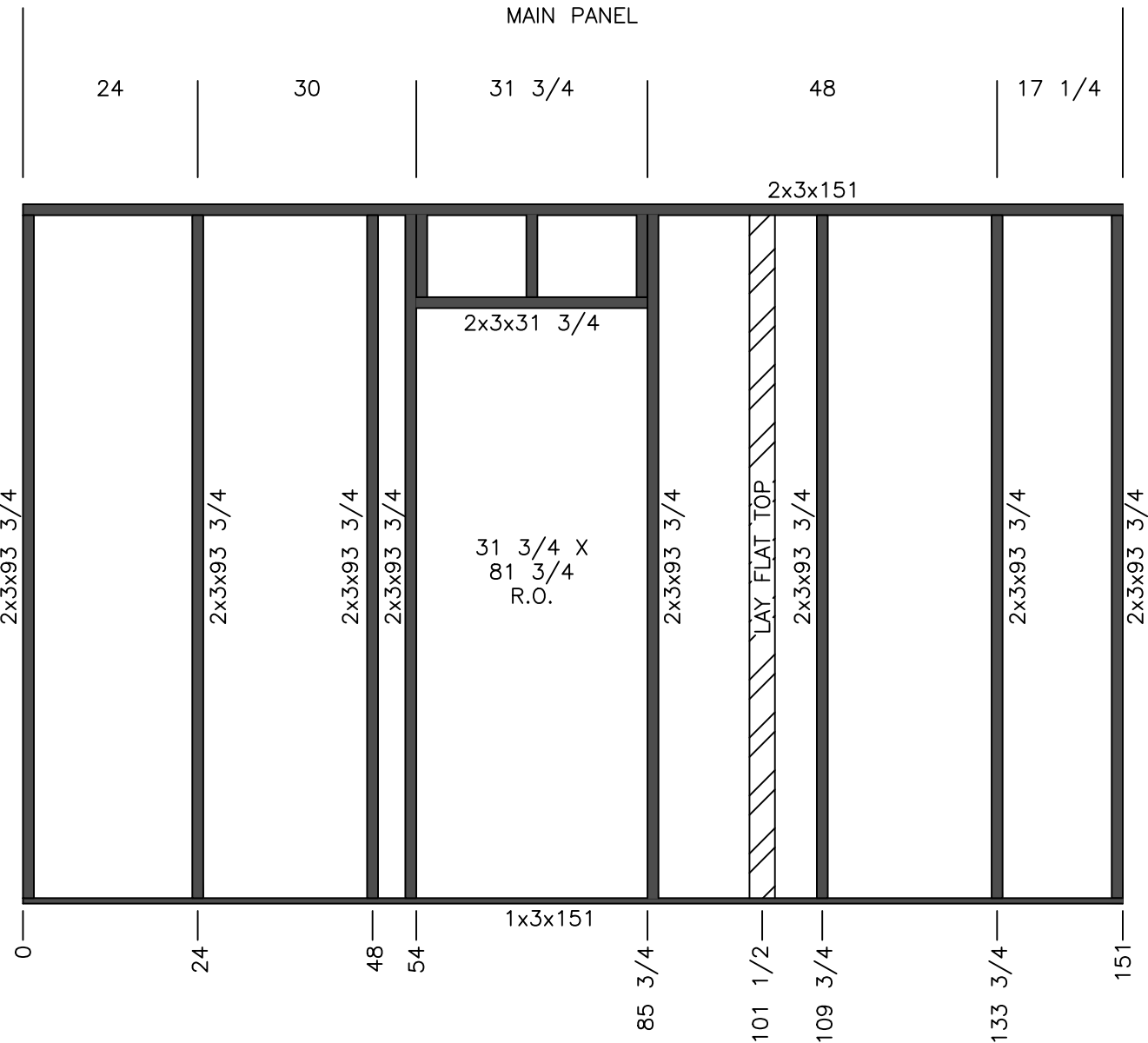

CUTLIST		
QTY	SIZE	TYPE
1	151	1x3
1	151	2x3
8	93 3/4	2x3
1	25 3/4	2x3
3	11 1/4	2x3
1	93 3/4 VLF<U>	1x4

STUD SPACING 24"

REFERENCE: WALL SET PRINT 34M176 BASE

 Appalachia - 934	MODEL #: EGL28765A	DRAWING #: 34M176
	DATE: 01/07/2020 SCALE: N.T.S.	
PRODUCT DESIGNER: D.C.S.	MODEL: 28' x 76' Eagle	
DESC: WALL 3	REV: 04/10/2020	

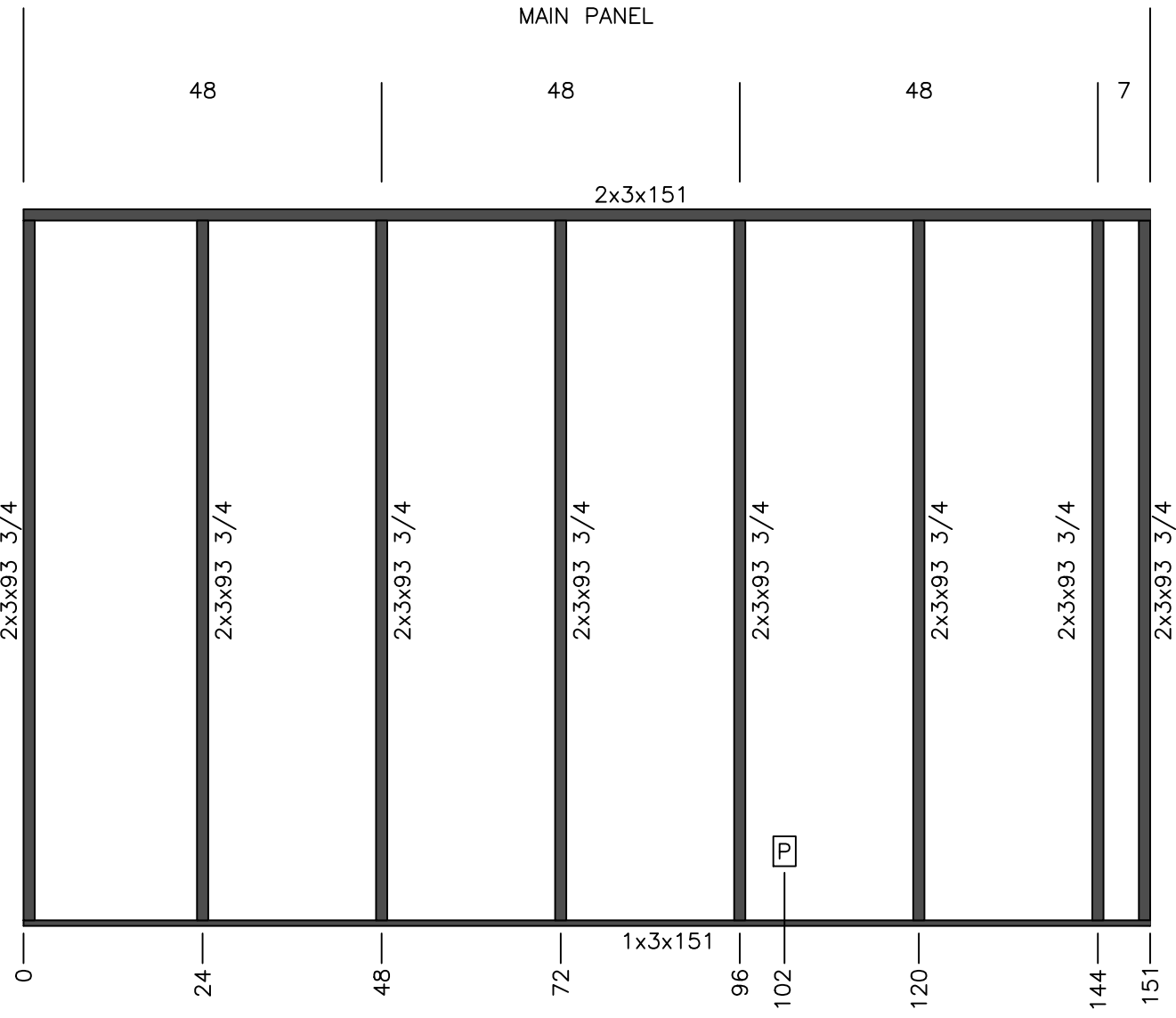

CUTLIST		
QTY	SIZE	TYPE
1	151	1x3
1	151	2x3
8	93 3/4	2x3

REFERENCE: WALL SET PRINT 34M176 BASE

 Appalachia - 934	MODEL #: EGL28765A	DRAWING #: 34M176
	DATE: 01/07/2020 SCALE: N.T.S.	
PRODUCT DESIGNER: D.C.S.	MODEL: 28' x 76' Eagle	
DESC: WALL 4	REV: 02/24/2020	

STUD SPACING 24"

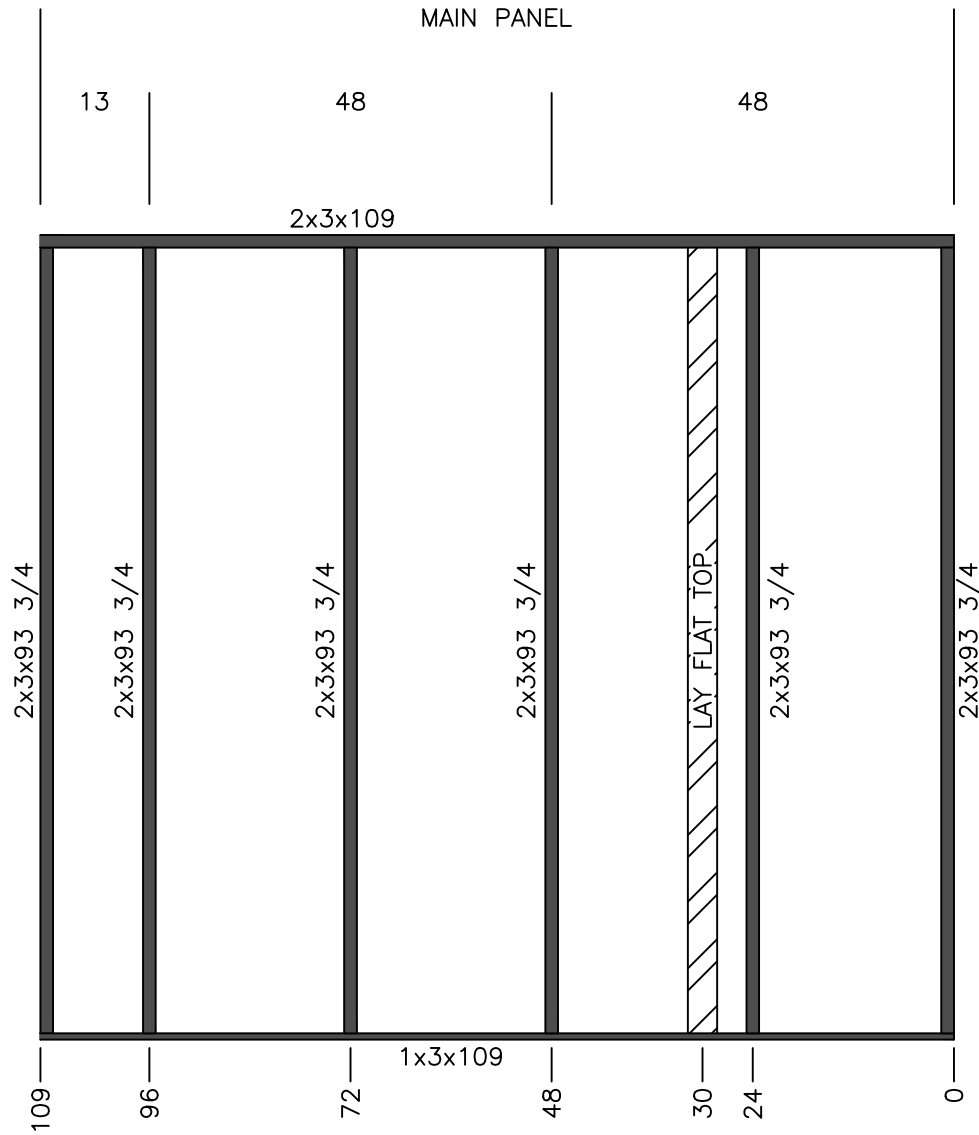

CUTLIST		
QTY	SIZE	TYPE
1	109	1x3
1	109	2x3
6	93 3/4	2x3
1	93 3/4 VLF<U>	1x4

REFERENCE: WALL SET PRINT 34M176 BASE

 Appalachia - 934	MODEL #: EGL28765A	DRAWING #: 34M176
	DATE: 01/07/2020 SCALE: N.T.S.	
PRODUCT DESIGNER: D.C.S.	MODEL: 28' x 76' Eagle	
DESC: WALL 5		REV:

STUD SPACING 24"

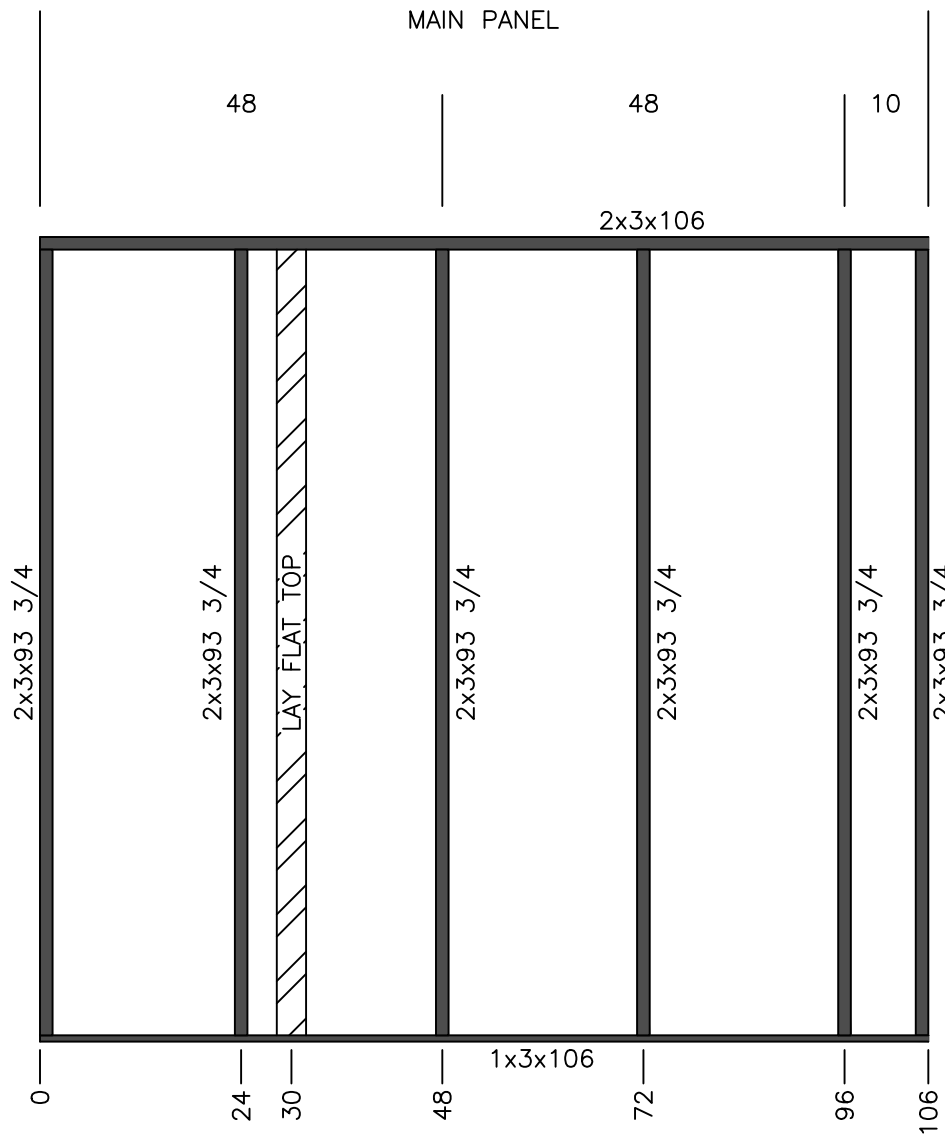

CUTLIST		
QTY	SIZE	TYPE
1	106	1x3
1	106	2x3
6	93 3/4	2x3
1	93 3/4 VLF<U>	1x4

REFERENCE: WALL SET PRINT 34M176 BASE

	MODEL #: EGL28765A	DRAWING #: 34M176
	DATE: 01/07/2020 SCALE: N.T.S.	
PRODUCT DESIGNER: D.C.S.	MODEL: 28' x 76' Eagle	
DESC: WALL 6		REV:

STUD SPACING 24"

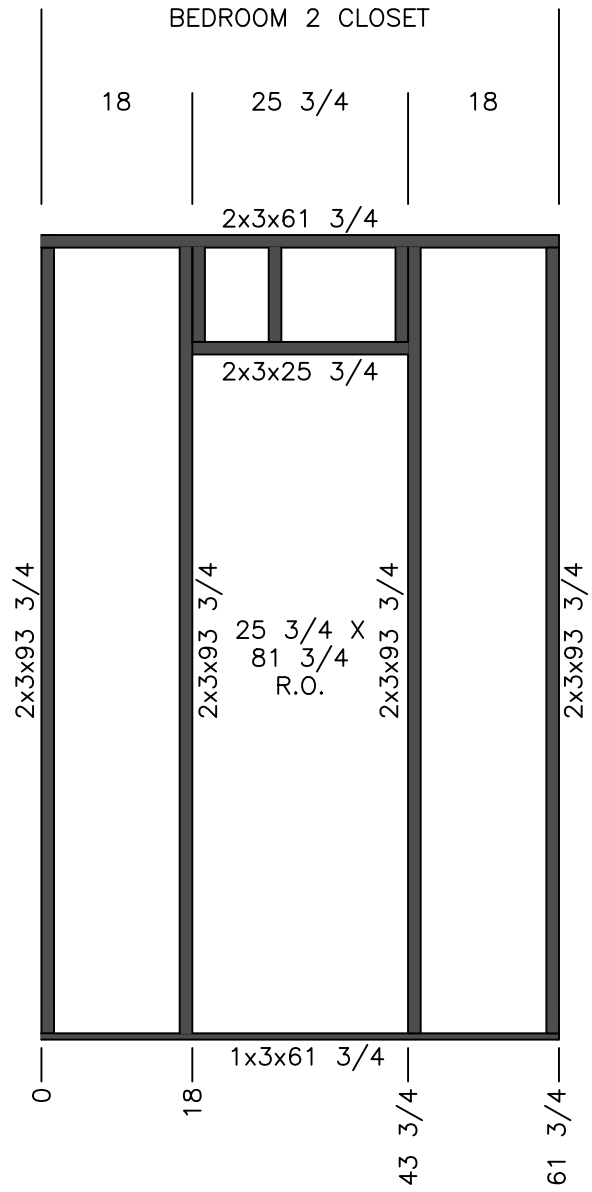

CUTLIST		
QTY	SIZE	TYPE
1	61 3/4	1x3
1	61 3/4	2x3
4	93 3/4	2x3
1	25 3/4	2x3
3	11 1/4	2x3

REFERENCE: WALL SET PRINT 34M176 BASE

	MODEL #: EGL28765A	DRAWING #: 34M176
	Appalachia - 934	
PRODUCT DESIGNER: D.C.S.	MODEL: 28' x 76' Eagle	
DESC: WALL 7		REV:

STUD SPACING 24"

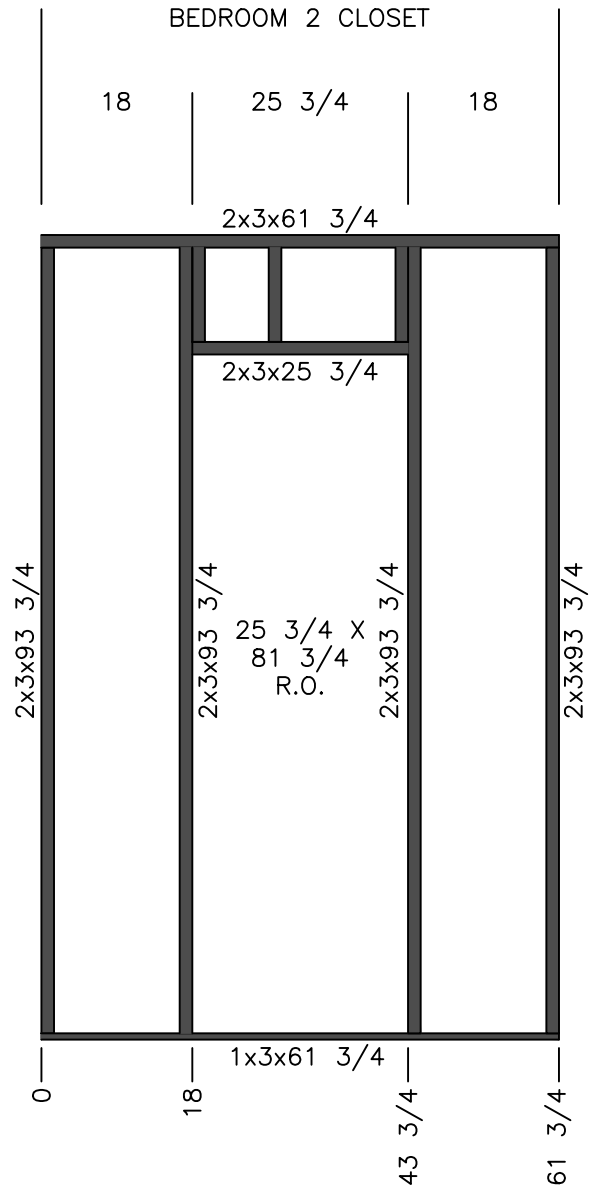

CUTLIST		
QTY	SIZE	TYPE
1	61 3/4	1x3
1	61 3/4	2x3
4	93 3/4	2x3
1	25 3/4	2x3
3	11 1/4	2x3

REFERENCE: WALL SET PRINT 34M176 BASE

	MODEL #: EGL28765A	DRAWING #: 34M176
	Appalachia - 934	
PRODUCT DESIGNER: D.C.S.	MODEL: 28' x 76' Eagle	
DESC: WALL 7		REV:

STUD SPACING 24"

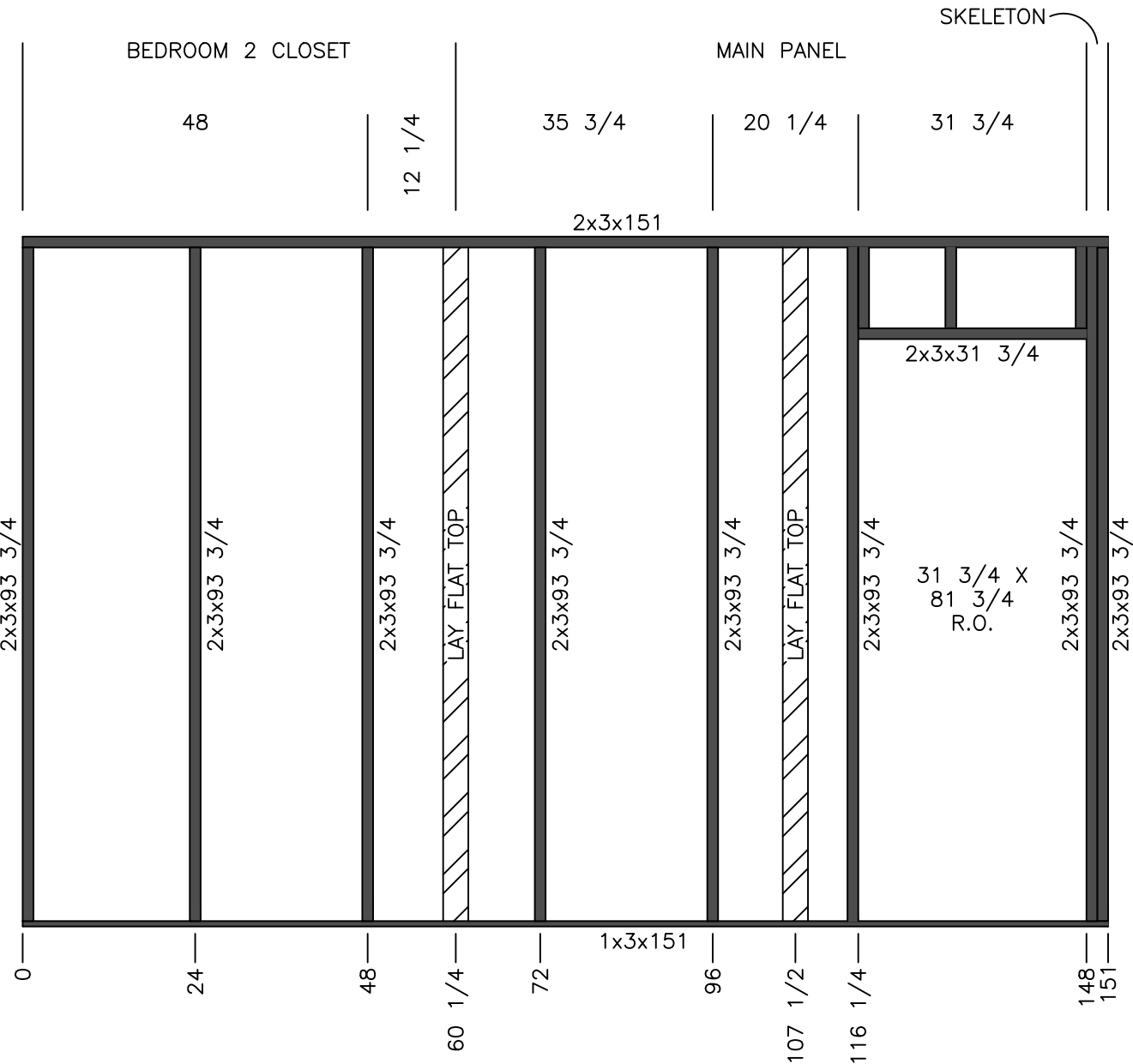

CUTLIST		
QTY	SIZE	TYPE
1	151	1x3
1	151	2x3
8	93 3/4	2x3
1	31 3/4	2x3
3	11 1/4	2x3
2	93 3/4 VLF<U>	1x4

STUD SPACING 24"

REFERENCE: WALL SET PRINT 34M176 BASE

 Appalachia - 934	MODEL #: EGL28765A	DRAWING #: 34M176
	DATE: 01/07/2020	
PRODUCT DESIGNER: D.C.S.	MODEL: 28' x 76' Eagle	
DESC: WALL 9	REV:	



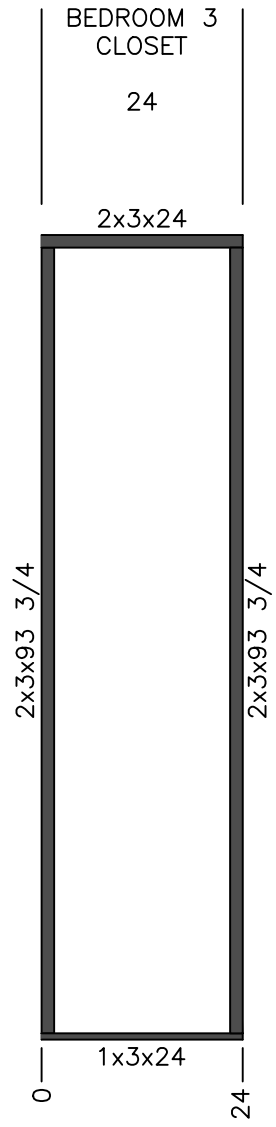

CUTLIST		
QTY	SIZE	TYPE
1	24	1x3
1	24	2x3
2	93 3/4	2x3

REFERENCE: WALL SET PRINT 34M176 BASE

 Appalachia - 934	MODEL #: EGL28765A	DRAWING #: 34M176
	DATE: 01/07/2020 SCALE: N.T.S.	
PRODUCT DESIGNER: D.C.S.	MODEL: 28' x 76' Eagle	
DESC: WALL 10		REV:

STUD SPACING 24"

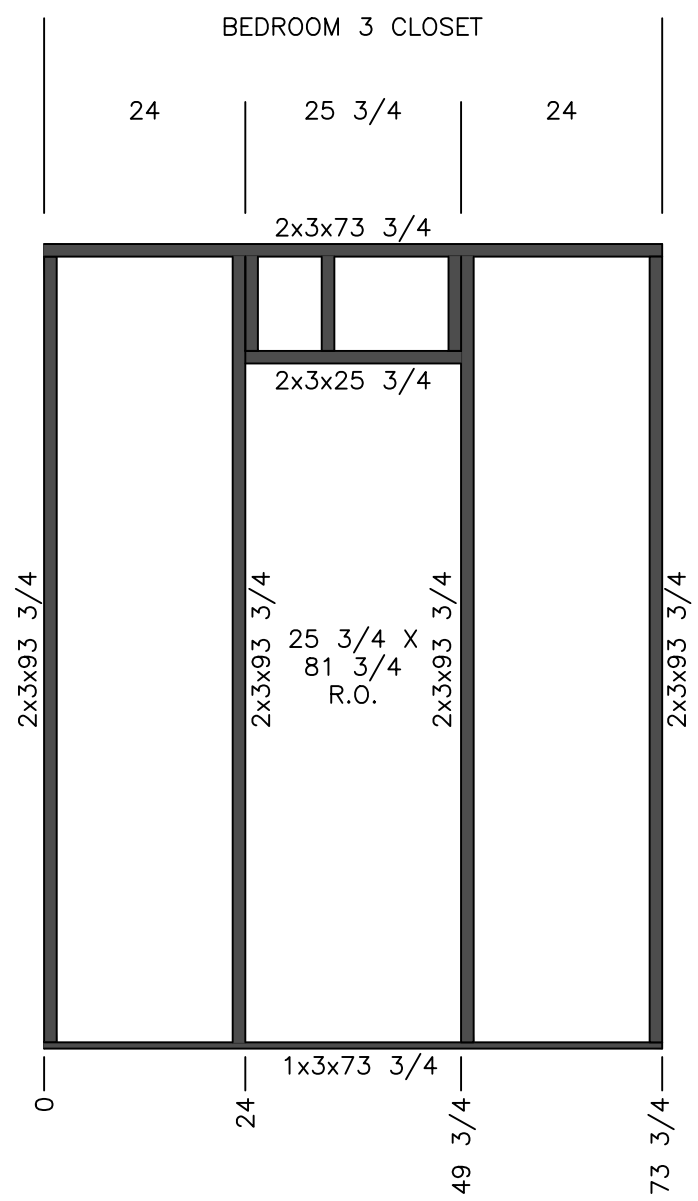

CUTLIST		
QTY	SIZE	TYPE
1	73 3/4	1x3
1	73 3/4	2x3
4	93 3/4	2x3
1	25 3/4	2x3
3	11 1/4	2x3

REFERENCE: WALL SET PRINT 34M176 BASE

<b>Clayton</b> Appalachia - 934	MODEL #: EGL28765A	DRAWING #: <b>34M176</b>
	DATE: 01/07/2020    SCALE: N.T.S.	
PRODUCT DESIGNER: D.C.S.	MODEL: 28' x 76' Eagle	
DESC: WALL 11		REV:

STUD SPACING 24"

CUTLIST

QTY	SIZE	TYPE
1	226 1/2	1x3
1	226 1/2	2x3
12	93 3/4	2x3
2	31 3/4	2x3
6	11 1/4	2x3
1	93 3/4 VLF <U>	1x6

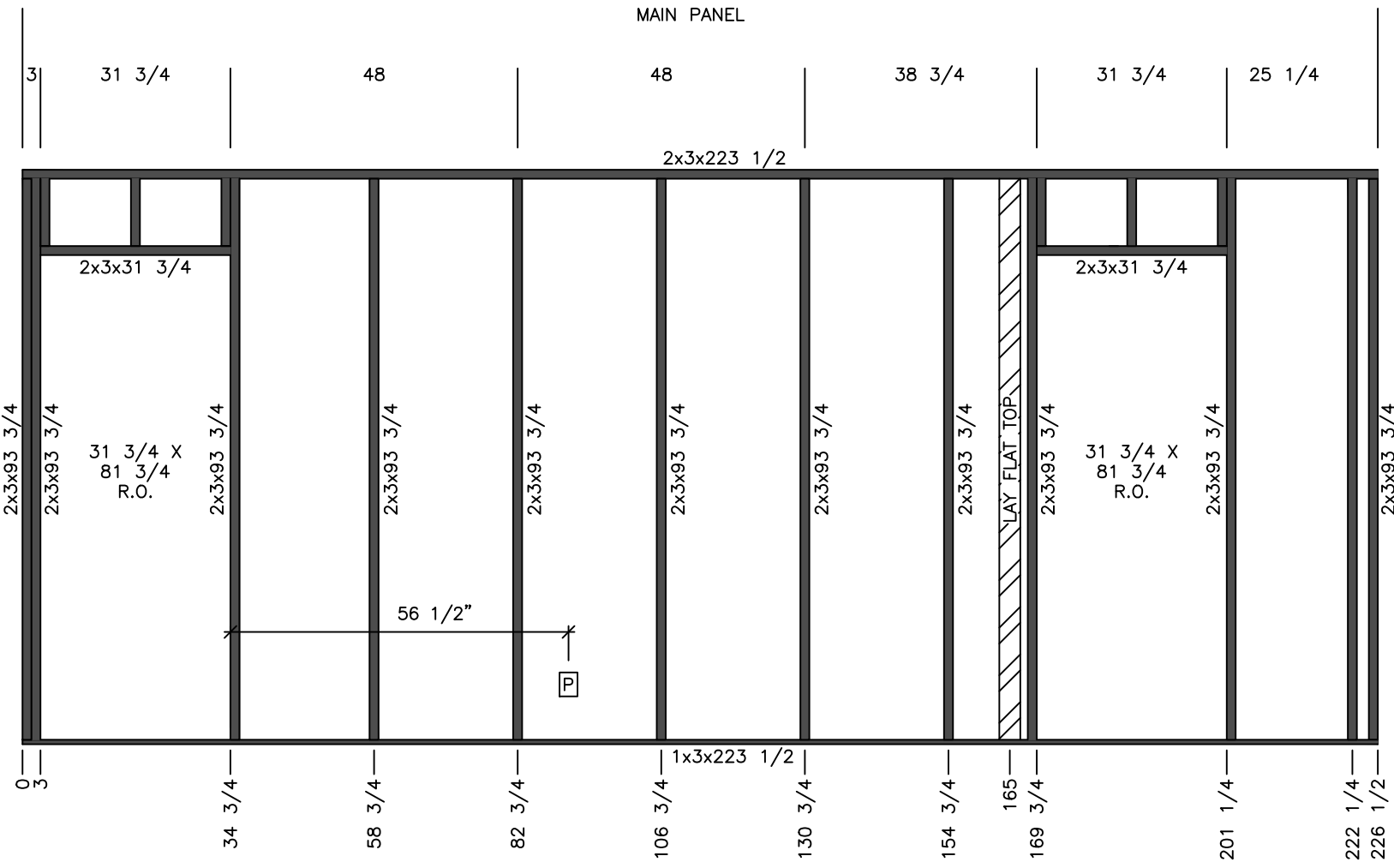

REFERENCE: WALL SET PRINT 34M176 BASE

 Appalachia - 934	MODEL #: EGL28765A	DRAWING #: 34M176
	DATE: 01/07/2020 SCALE: N.T.S.	
PRODUCT DESIGNER: D.C.S.	MODEL: 28' x 76' Eagle	
DESC: WALL 12	REV: 02/24/2020	

STUD SPACING 24"

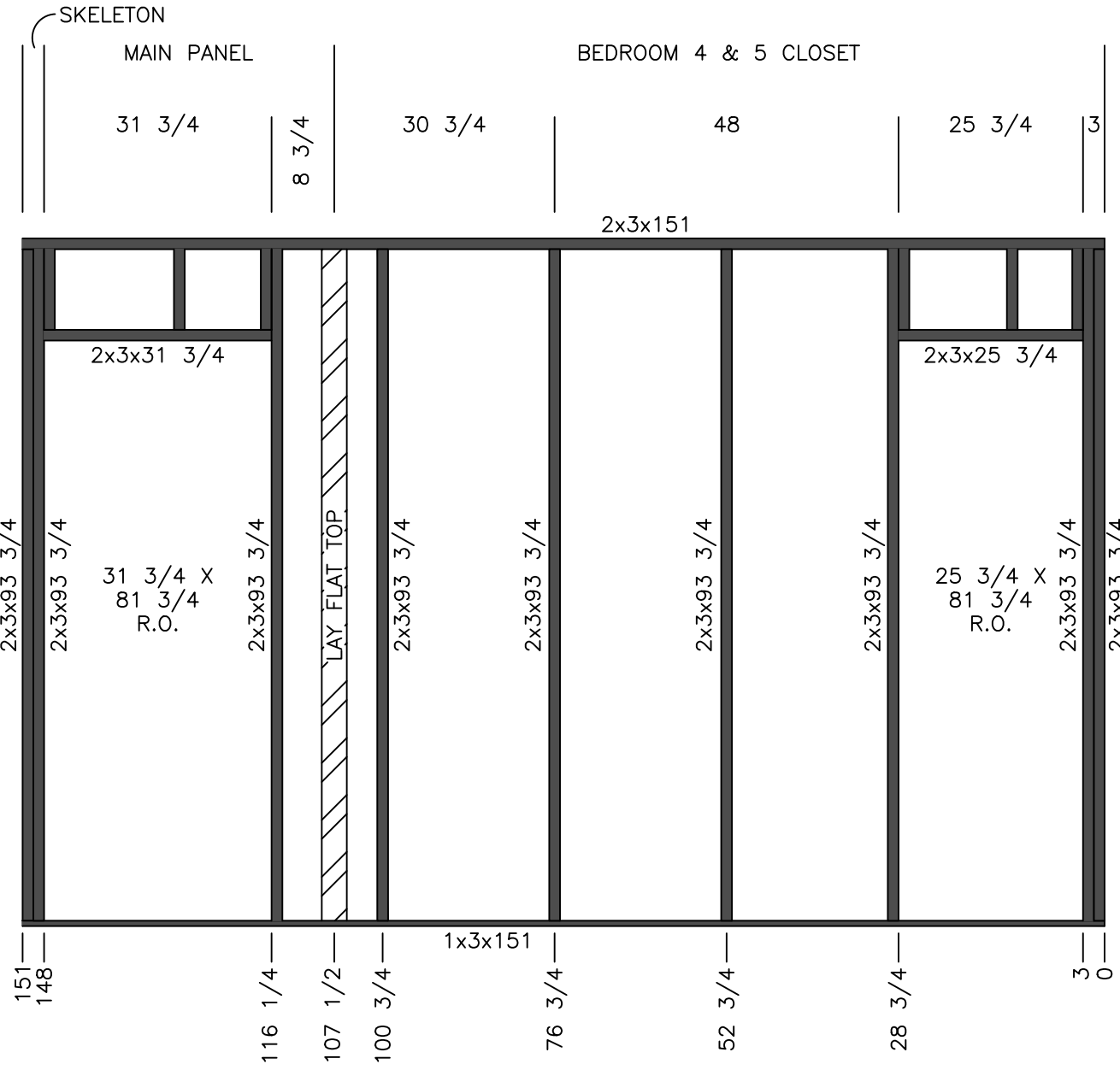

CUTLIST		
QTY	SIZE	TYPE
1	151	1x3
1	151	2x3
9	93 3/4	2x3
1	31 3/4	2x3
1	25 3/4	2x3
6	11 1/4	2x3
1	93 3/4 VLF<U>	1x4

STUD SPACING 24"

REFERENCE: WALL SET PRINT 34M176 BASE

	MODEL #: EGL28765A	DRAWING #: 34M176
	Appalachia - 934	
PRODUCT DESIGNER: D.C.S.	MODEL: 28' x 76' Eagle	
DESC: WALL 13		REV:

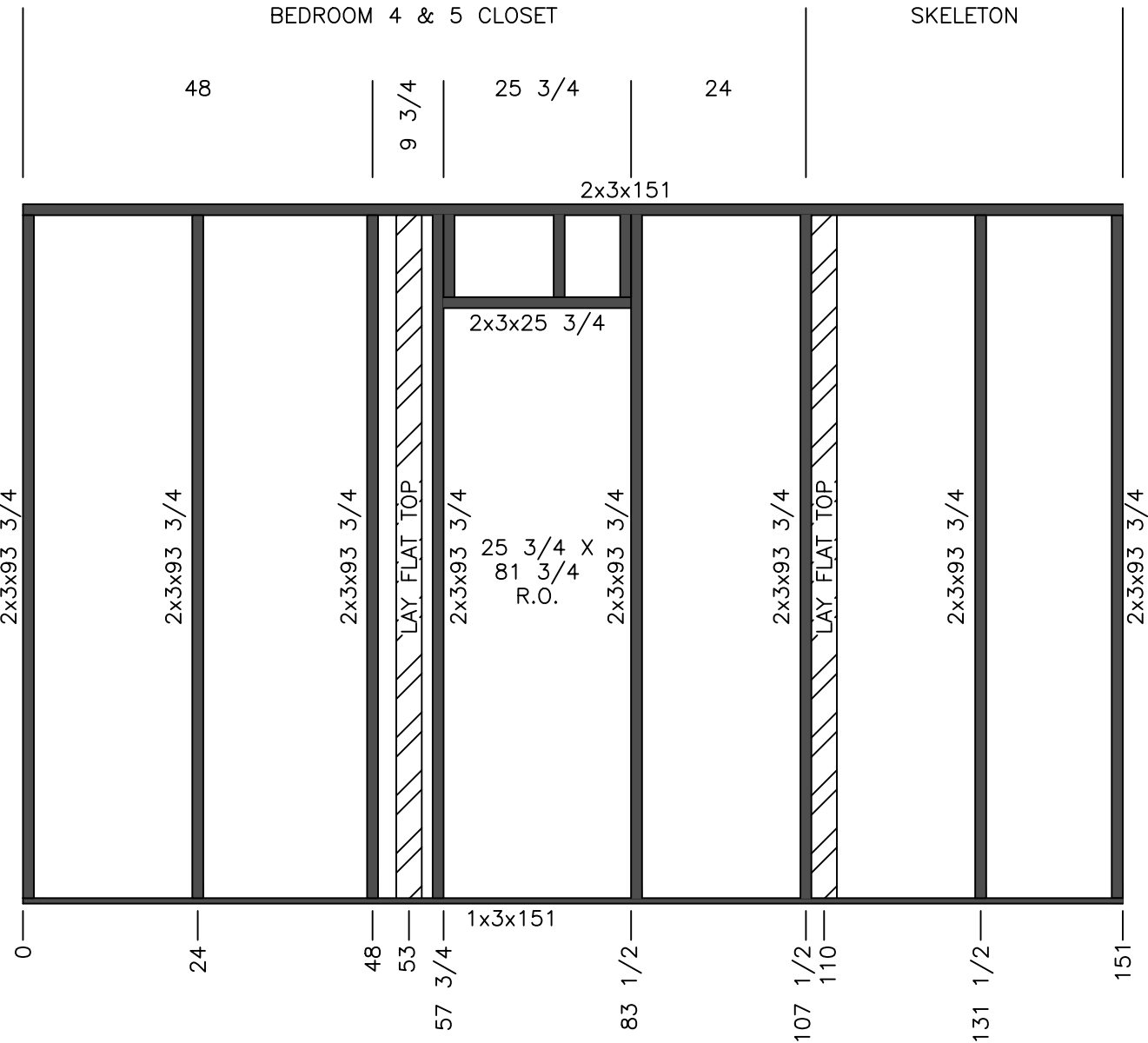

CUTLIST		
QTY	SIZE	TYPE
1	151	1x3
1	151	2x3
8	93 3/4	2x3
1	25 3/4	2x3
3	11 1/4	2x3
2	93 3/4 VLF<U>	1x4

REFERENCE: WALL SET PRINT 34M176 BASE

 Appalachia - 934	MODEL #: EGL28765A	DRAWING #: 34M176
	DATE: 01/07/2020	
PRODUCT DESIGNER: D.C.S.	MODEL: 28' x 76' Eagle	
DESC: WALL 14	REV: 02/24/2020	

STUD SPACING 24"

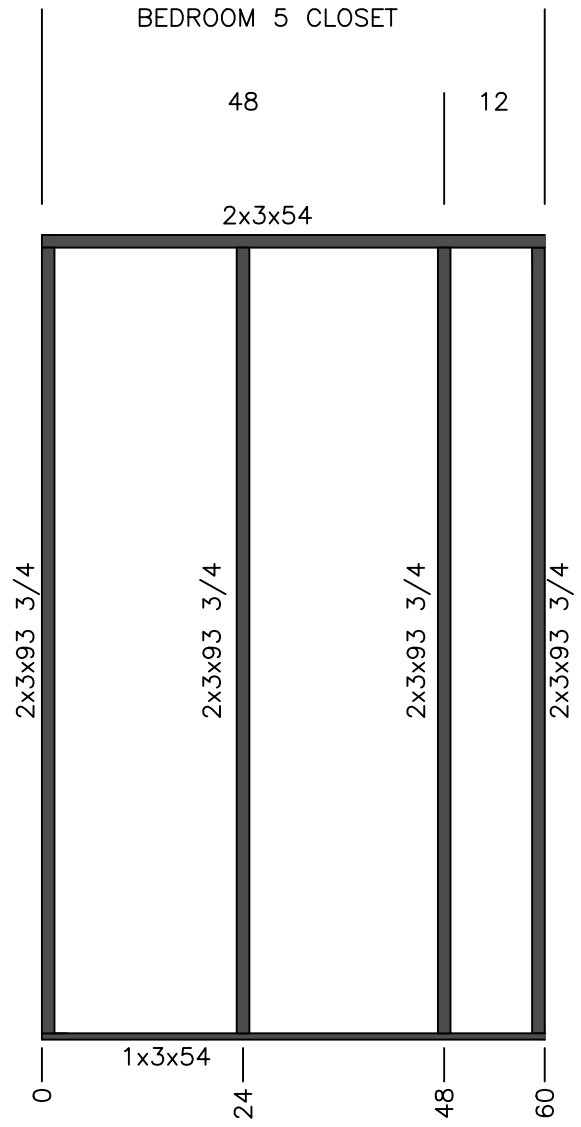

CUTLIST		
QTY	SIZE	TYPE
1	60	1x3
1	60	2x3
4	93 3/4	2x3

REFERENCE: WALL SET PRINT 34M176 BASE

 Appalachia - 934	MODEL #: EGL28765A	DRAWING #: 34M176
	DATE: 01/07/2020 SCALE: N.T.S.	
PRODUCT DESIGNER: D.C.S.	MODEL: 28' x 76' Eagle	
DESC: WALL 15	REV:	

STUD SPACING 24"

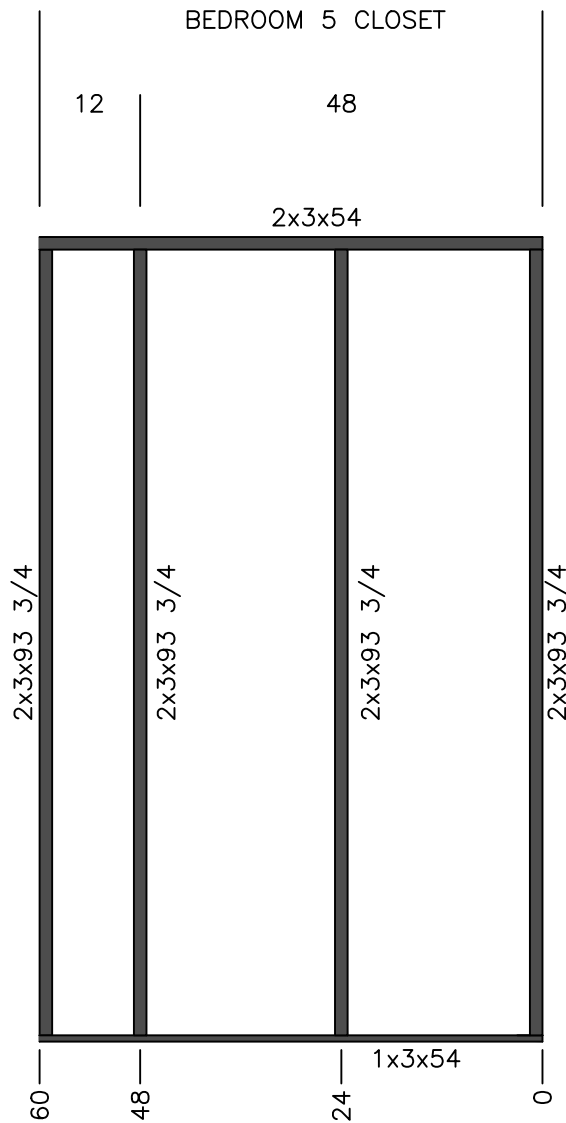

CUTLIST		
QTY	SIZE	TYPE
1	60	1x3
1	60	2x3
4	93 3/4	2x3

REFERENCE: WALL SET PRINT 34M176 BASE

 Appalachia - 934	MODEL #: EGL28765A	DRAWING #: 34M176
	DATE: 01/07/2020 SCALE: N.T.S.	
PRODUCT DESIGNER: D.C.S.	MODEL: 28' x 76' Eagle	
DESC: WALL 16		REV:

STUD SPACING 24"

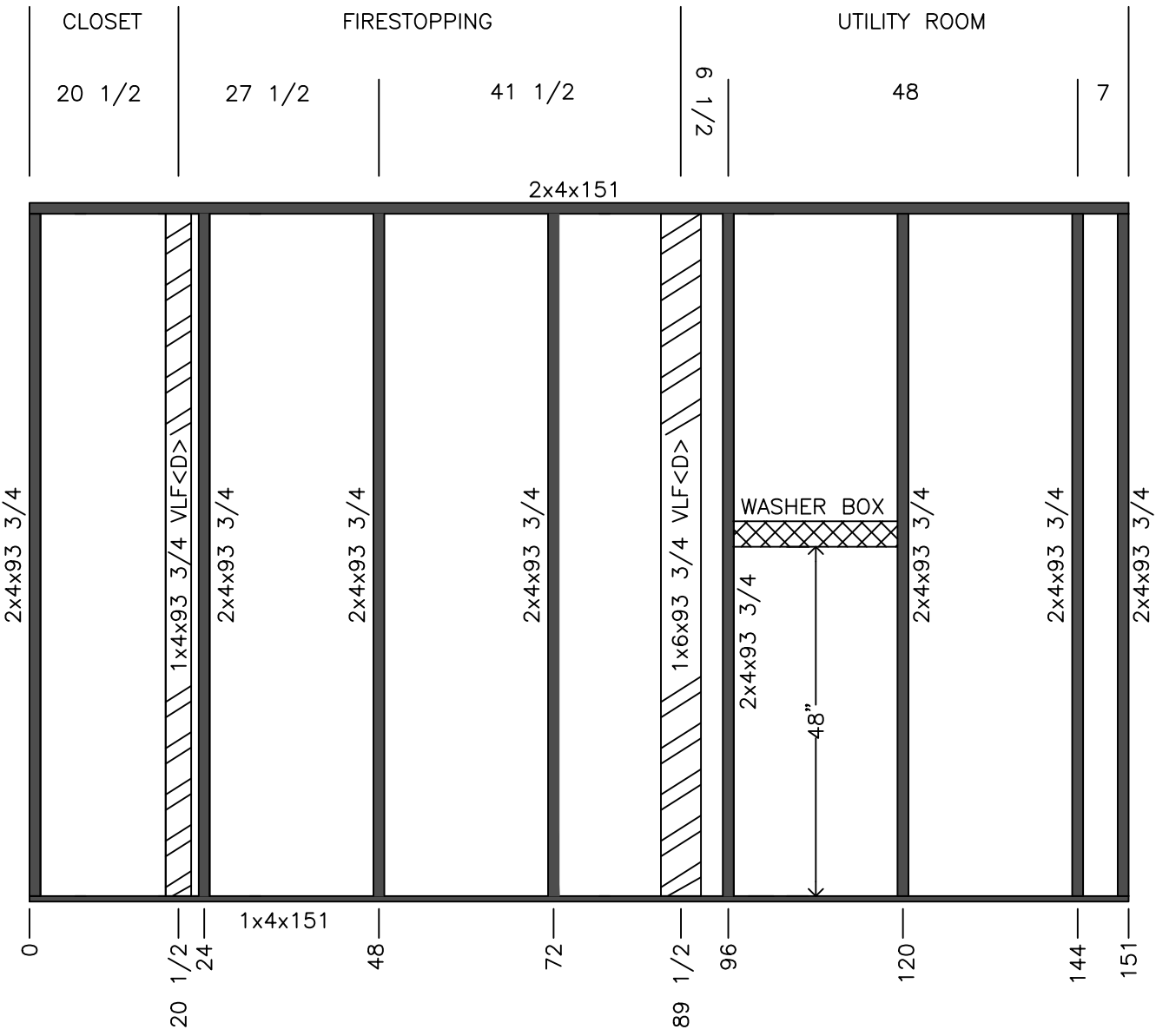

CUTLIST		
QTY	SIZE	TYPE
1	151	1x4
1	151	2x4
8	93 3/4	2x4
1	93 3/4 VLF<D>	1x6
1	93 3/4 VLF<D>	1x4

REFERENCE: WALL SET PRINT 34M176 BASE

	MODEL #: EGL28765A	DRAWING #: 34M213
	DATE: 07/03/2023 SCALE: N.T.S.	
PRODUCT DESIGNER: D.C.S.	MODEL: 28' x 76' Eagle	
DESC: WALL 17		REV:

STUD SPACING 24"



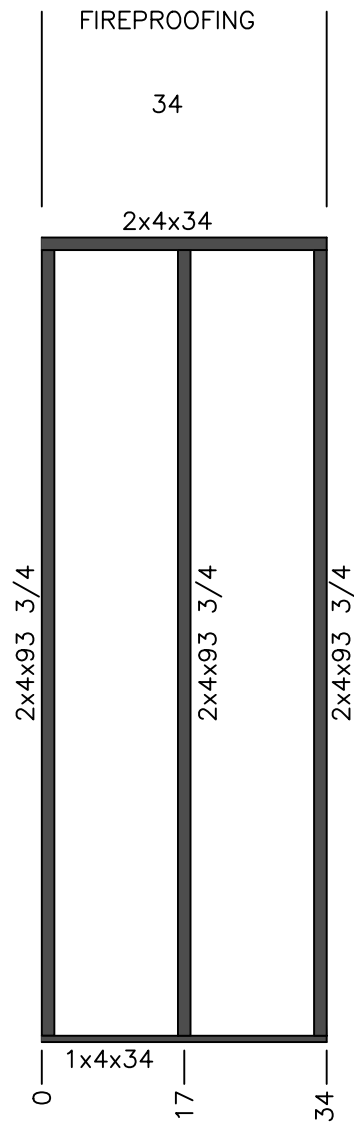

CUTLIST		
QTY	SIZE	TYPE
1	34	1x4
1	34	2x4
3	93 3/4	2x4

REFERENCE: WALL SET PRINT 34M176 BASE

 Appalachia - 934	MODEL #: EGL28765A	DRAWING #: 34M213
	DATE: 07/03/2023 SCALE: N.T.S.	
PRODUCT DESIGNER: B.K.R.	MODEL: 28' x 76' Eagle	
DESC: WALL 18		REV:

STUD SPACING 24"

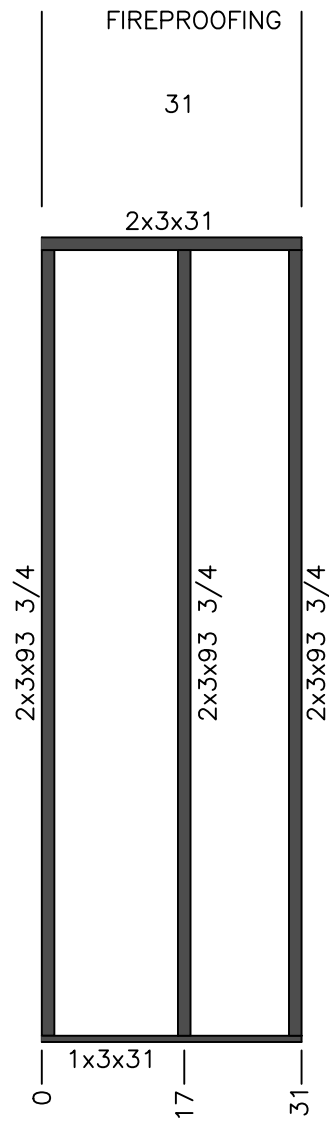

CUTLIST		
QTY	SIZE	TYPE
1	31	1x3
1	31	2x3
3	93 3/4	2x3

REFERENCE: WALL SET PRINT 34M176 BASE

 Appalachia - 934	MODEL #: EGL28765A	DRAWING #: 34M213
	DATE: 07/03/2023   SCALE: N.T.S.	
PRODUCT DESIGNER: B.K.R.	MODEL: 28' x 76' Eagle	
DESC: WALL 19		REV:

STUD SPACING 24"

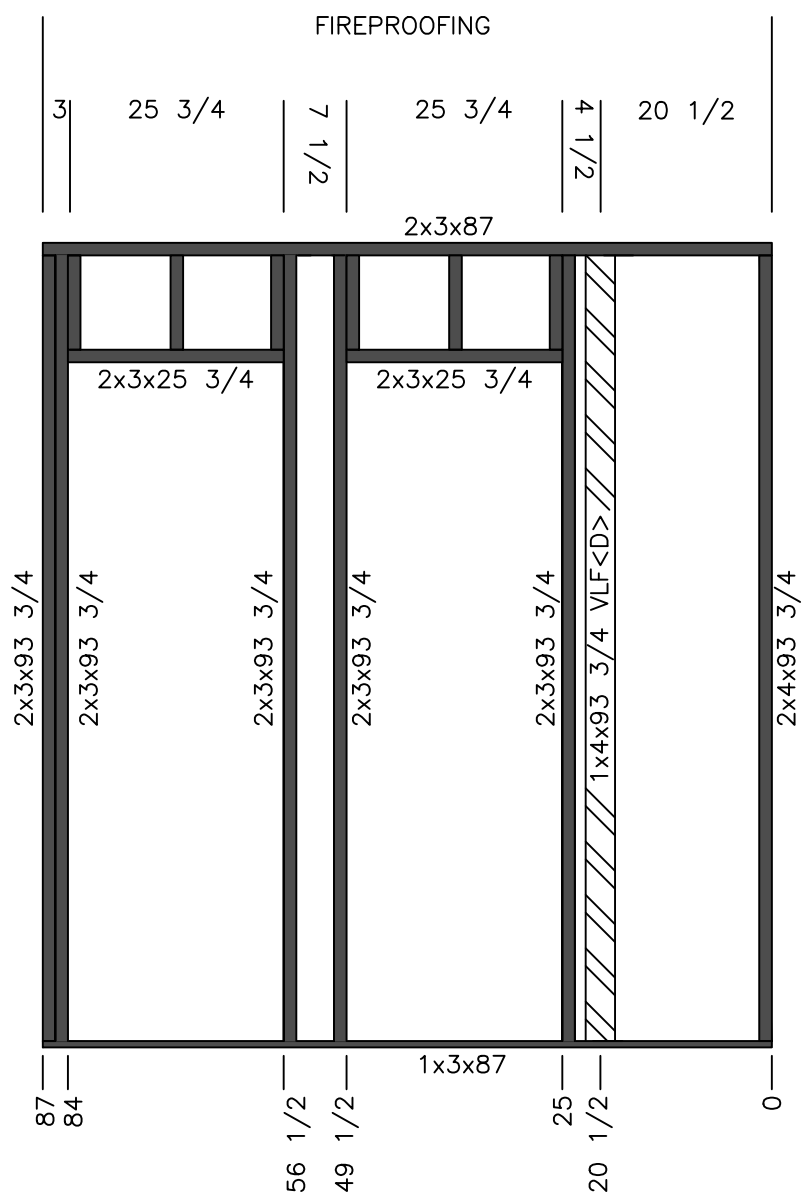

CUTLIST		
QTY	SIZE	TYPE
1	87	1x3
1	87	2x3
6	93 3/4	2x3
2	25 3/4	2x3
6	11 1/4	2x3

REFERENCE: WALL SET PRINT 34M176 BASE

 <b>Clayton</b> Appalachia - 934	MODEL #: EGL28765A	DRAWING #: <b>34M213</b>
	DATE: 07/03/2023 SCALE: N.T.S.	
PRODUCT DESIGNER: B.K.R.	MODEL: <b>28' x 76' Eagle</b>	
DESC: WALL 20		REV:

STUD SPACING 24"

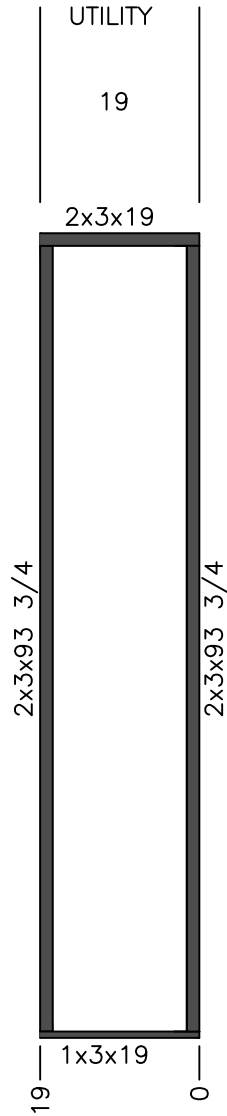

CUTLIST		
QTY	SIZE	TYPE
1	19	1x4
1	19	2x4
2	93 3/4	2x4

REFERENCE: WALL SET PRINT 34M176 BASE

 Appalachia - 934	MODEL #: EGL28765A	DRAWING #: 34M220
	DATE: 07/03/2023 SCALE: N.T.S.	
PRODUCT DESIGNER: B.K.R.	MODEL: 28' x 76' Eagle	
DESC: WALL 21		REV:

STUD SPACING 24"

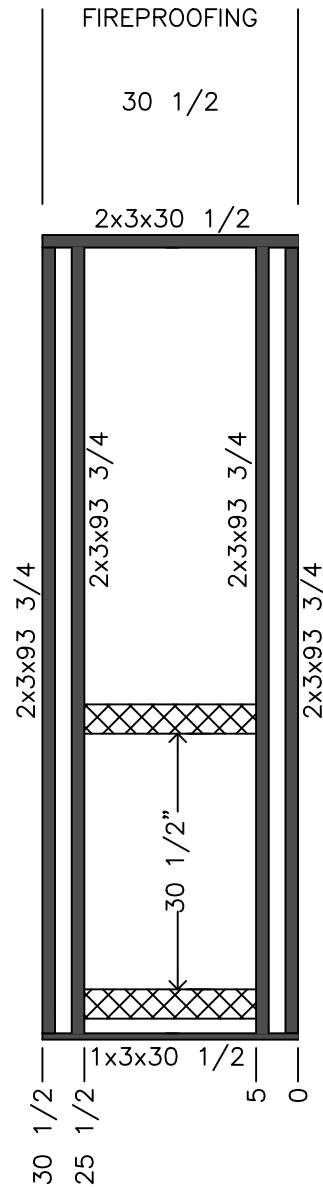

CUTLIST		
QTY	SIZE	TYPE
1	30 1/2	1x3
1	30 1/2	2x3
4	93 3/4	2x3

REFERENCE: WALL SET PRINT 34M176 BASE

	MODEL #: EGL28765A	DRAWING #: 34M176
	DATE: 01/07/2020 SCALE: N.T.S.	
PRODUCT DESIGNER: D.C.S.	MODEL: 28' x 76' Eagle	
DESC: WALL 22		REV:

STUD SPACING 24"



CUTLIST		
QTY	SIZE	TYPE
1	32	1x3
1	32	2x3
3	93 3/4	2x3

REFERENCE: WALL SET PRINT 34M176 BASE

	MODEL #: EGL28765A	DRAWING #: 34M176
	DATE: 01/07/2020 SCALE: N.T.S.	
PRODUCT DESIGNER: D.C.S.	MODEL: 28' x 76' Eagle	
DESC: WALL 23		REV:

STUD SPACING 24"

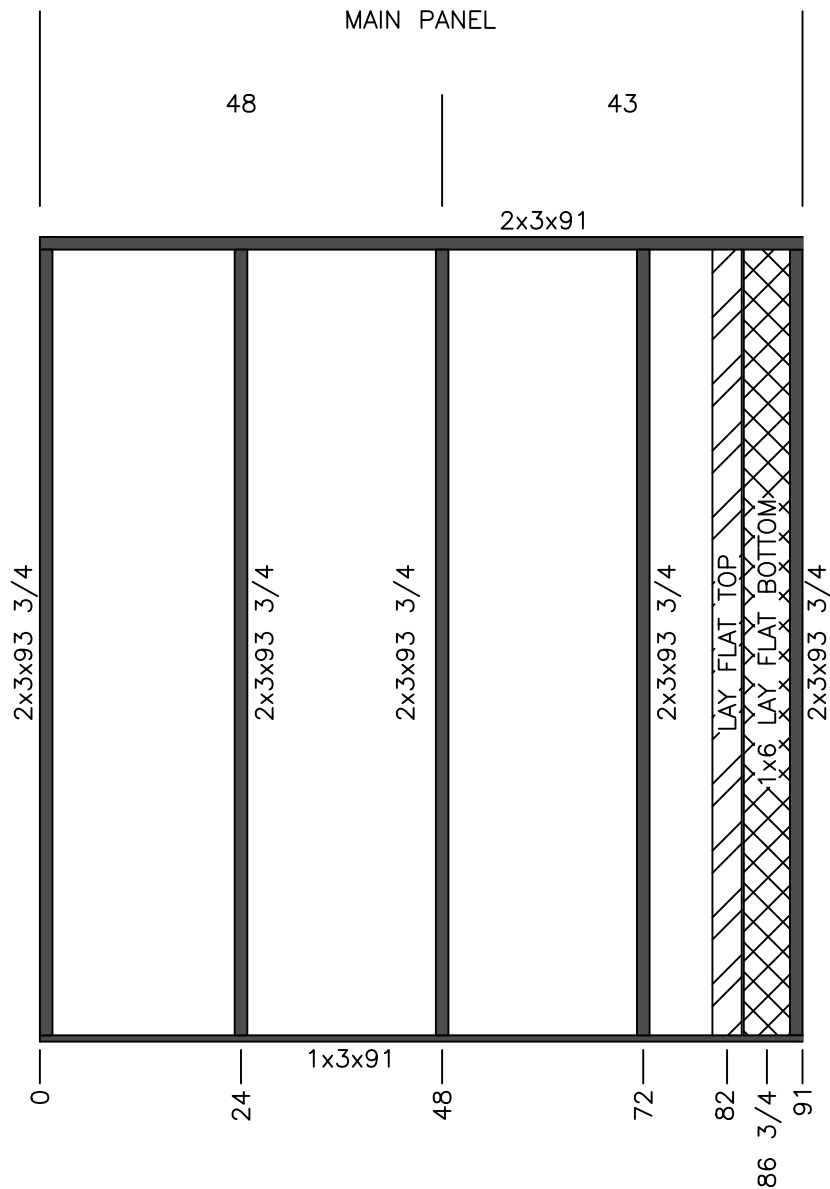

CUTLIST		
QTY	SIZE	TYPE
1	91	1x3
1	91	2x3
5	93 3/4	2x3
1	93 3/4 VLF<D>	1x6
1	93 3/4 VLF<U>	1x4

REFERENCE: WALL SET PRINT 34M176 BASE

 Appalachia - 934	MODEL #: EGL28765A	DRAWING #: 34M213
	DATE: 07/03/2023 SCALE: N.T.S.	
PRODUCT DESIGNER: B.K.R.	MODEL: 28' x 76' Eagle	
DESC: WALL 24		REV:

STUD SPACING 24"

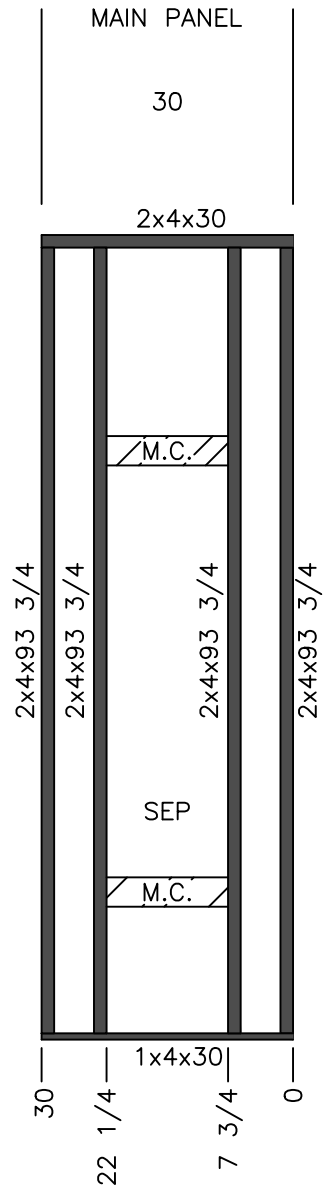

CUTLIST		
QTY	SIZE	TYPE
1	30	1x4
1	30	2x4
4	93 3/4	2x4

REFERENCE: WALL SET PRINT 34M176 BASE

 Appalachia - 934	MODEL #: EGL28765A	DRAWING #: 34M176
	DATE: 01/07/2020 SCALE: N.T.S.	
PRODUCT DESIGNER: D.C.S.	MODEL: 28' x 76' Eagle	
DESC: WALL 25	REV: 02/24/2020	

STUD SPACING 24"



SKELETON

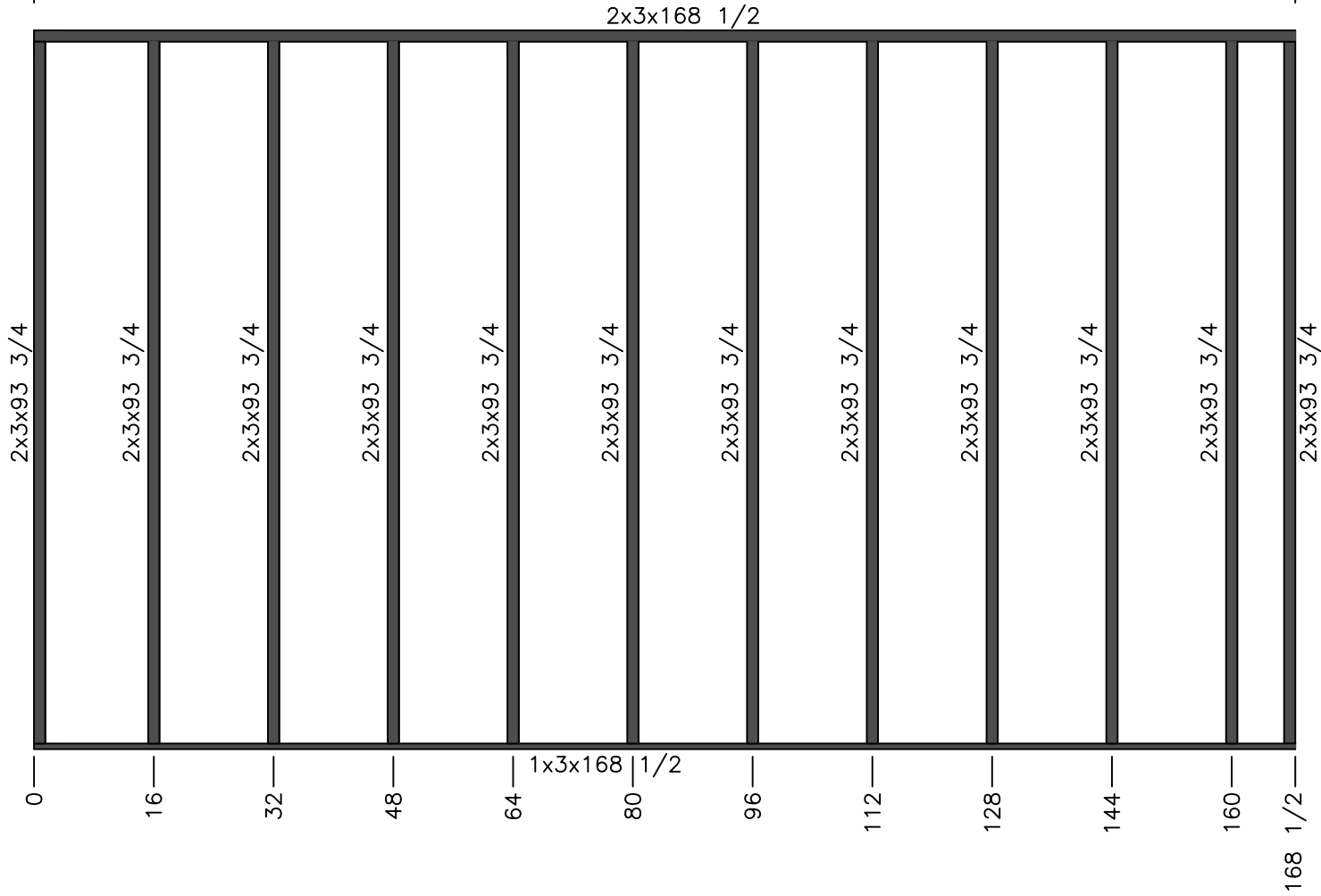

CUTLIST

QTY	SIZE	TYPE
1	168 1/2	1x3
1	168 1/2	2x3
12	93 3/4	2x3

REFERENCE: WALL SET PRINT 34M176 BASE

 Appalachia - 934	MODEL #: EGL28765A	DRAWING #: <b>34M176</b>
	DATE: 01/07/2020 SCALE: N.T.S.	
PRODUCT DESIGNER: D.C.S.	MODEL: 28' x 76' Eagle	
DESC: WALL 26		REV:

STUD SPACING 16"

SKELETON

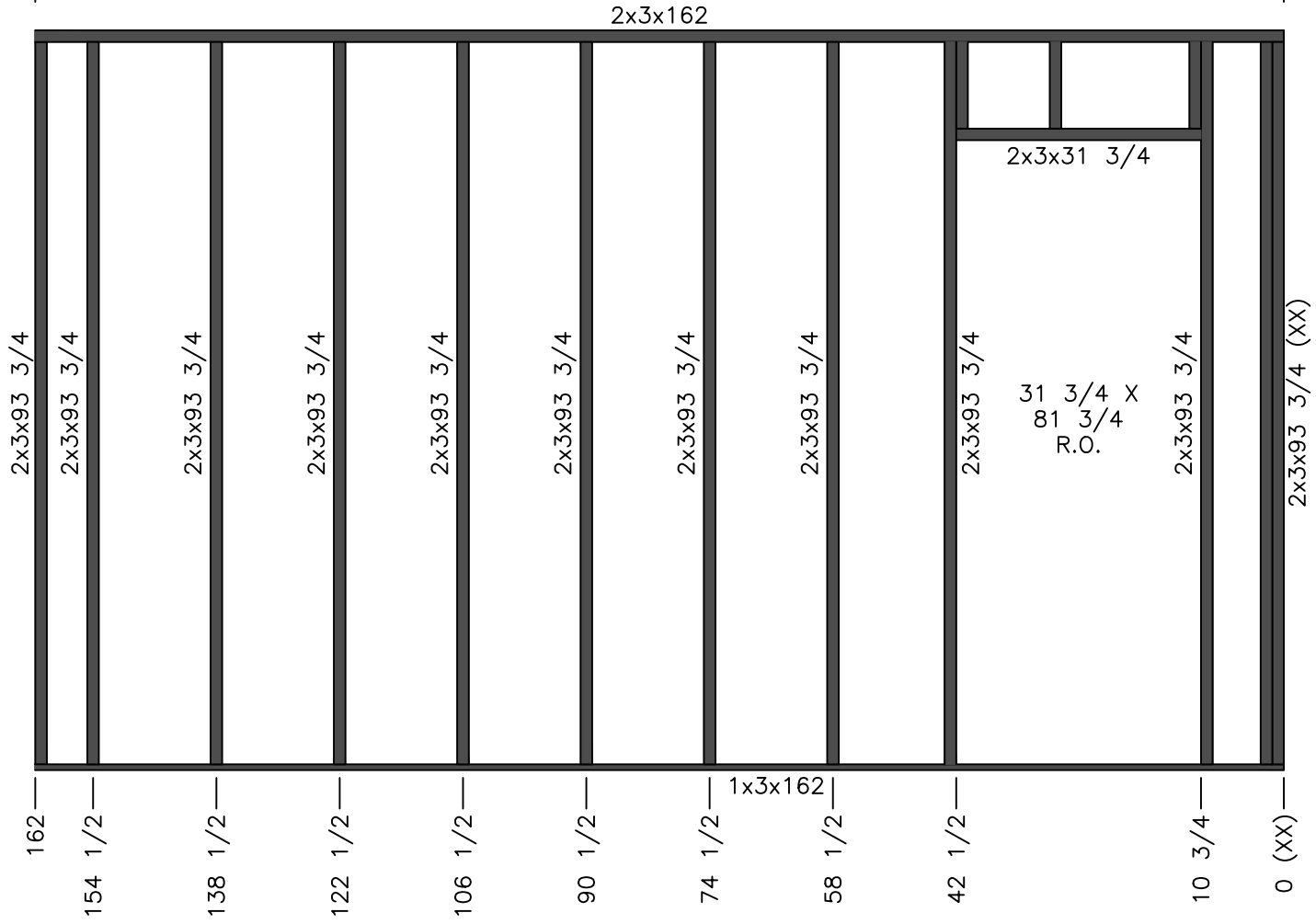

CUTLIST

QTY	SIZE	TYPE
1	162	1x3
1	162	2x3
12	93 3/4	2x3
1	31 3/4	2x3
3	11 1/4	2x3

STUD SPACING 16"

REFERENCE: WALL SET PRINT 34M176 BASE

 Appalachia - 934	MODEL #: EGL28765A	DRAWING #: 34M176
	DATE: 01/07/2020 SCALE: N.T.S.	
PRODUCT DESIGNER: D.C.S.	MODEL: 28' x 76' Eagle	
DESC: WALL 27		REV:

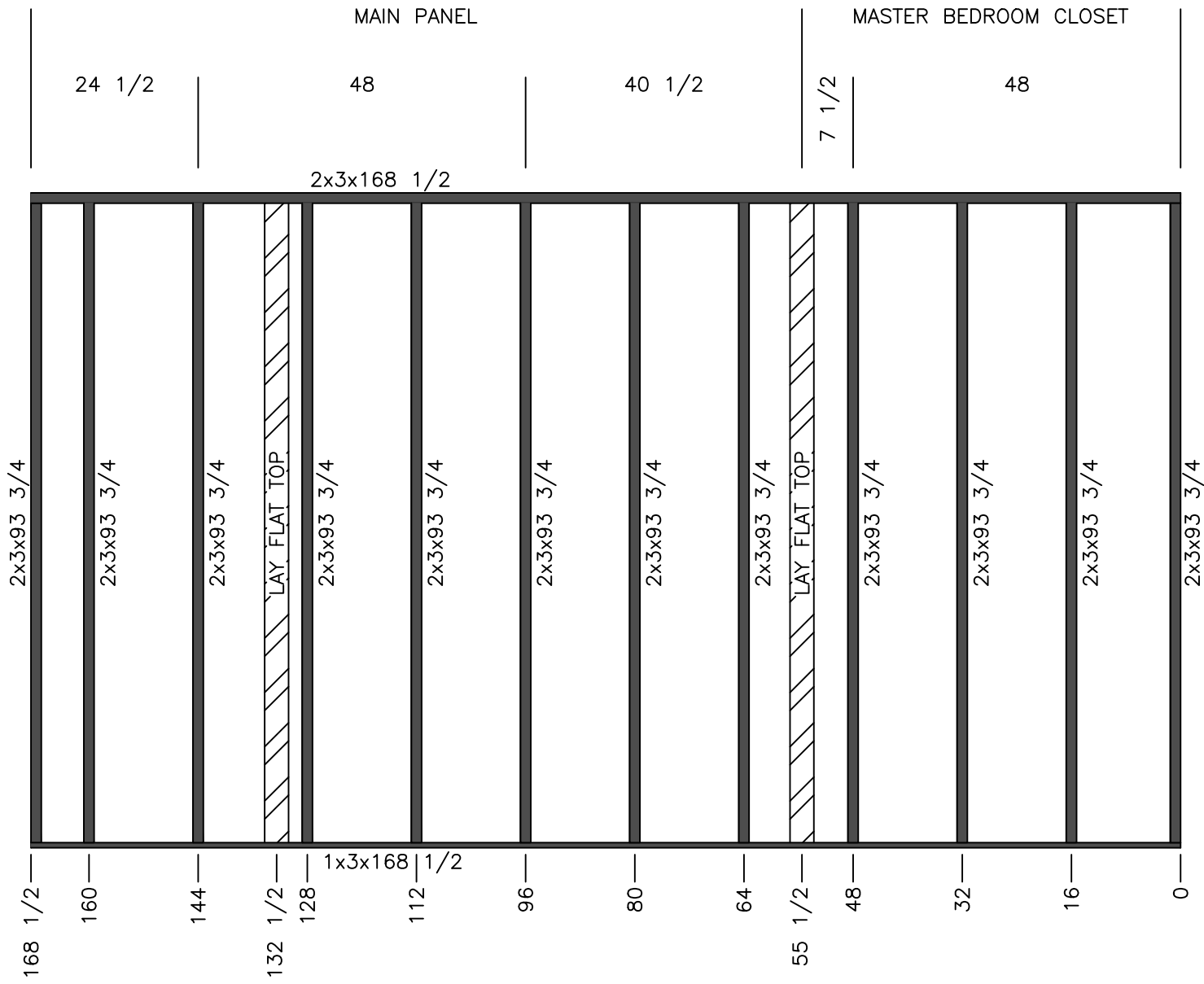

CUTLIST		
QTY	SIZE	TYPE
1	168 1/2	1x3
1	168 1/2	2x3
12	93 3/4	2x3
2	93 3/4 VLF<U>	1x4

REFERENCE: WALL SET PRINT 34M176 BASE

	MODEL #: EGL28765A	DRAWING #: 34M176
	DATE: 01/07/2020 SCALE: N.T.S.	
PRODUCT DESIGNER: D.C.S.	MODEL: 28' x 76' Eagle	
DESC: WALL 28		REV:

STUD SPACING 16"

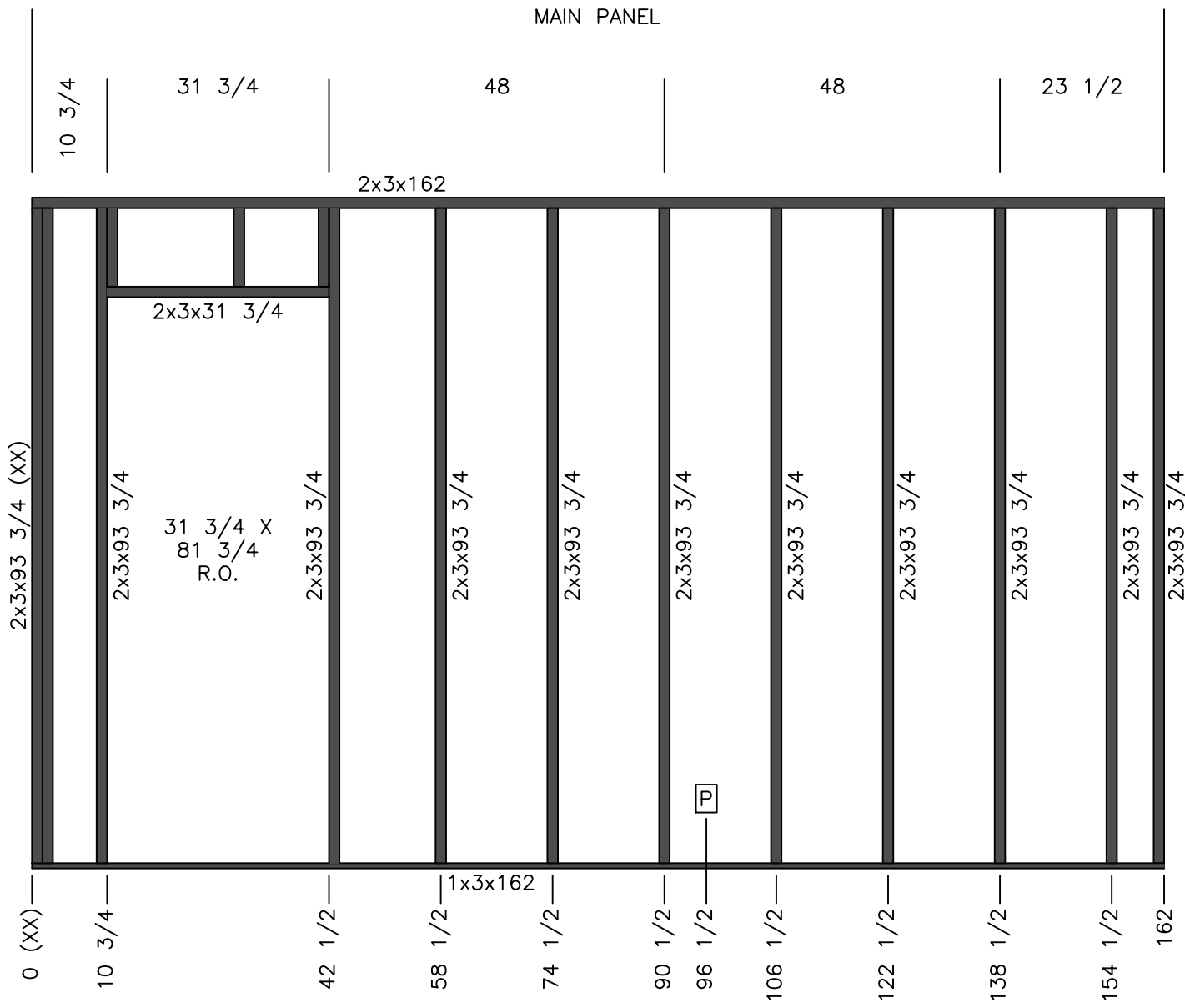

CUTLIST		
QTY	SIZE	TYPE
1	162	1x3
1	162	2x3
12	93 3/4	2x3
1	31 3/4	2x3
3	11 1/4	2x3

STUD SPACING 16"

REFERENCE: WALL SET PRINT 34M176 BASE

 Appalachia - 934	MODEL #: EGL28765A	DRAWING #: 34M176
	DATE: 01/07/2020	
PRODUCT DESIGNER: D.C.S.	MODEL: 28' x 76' Eagle	
DESC: WALL 29	REV: 02/24/2020	

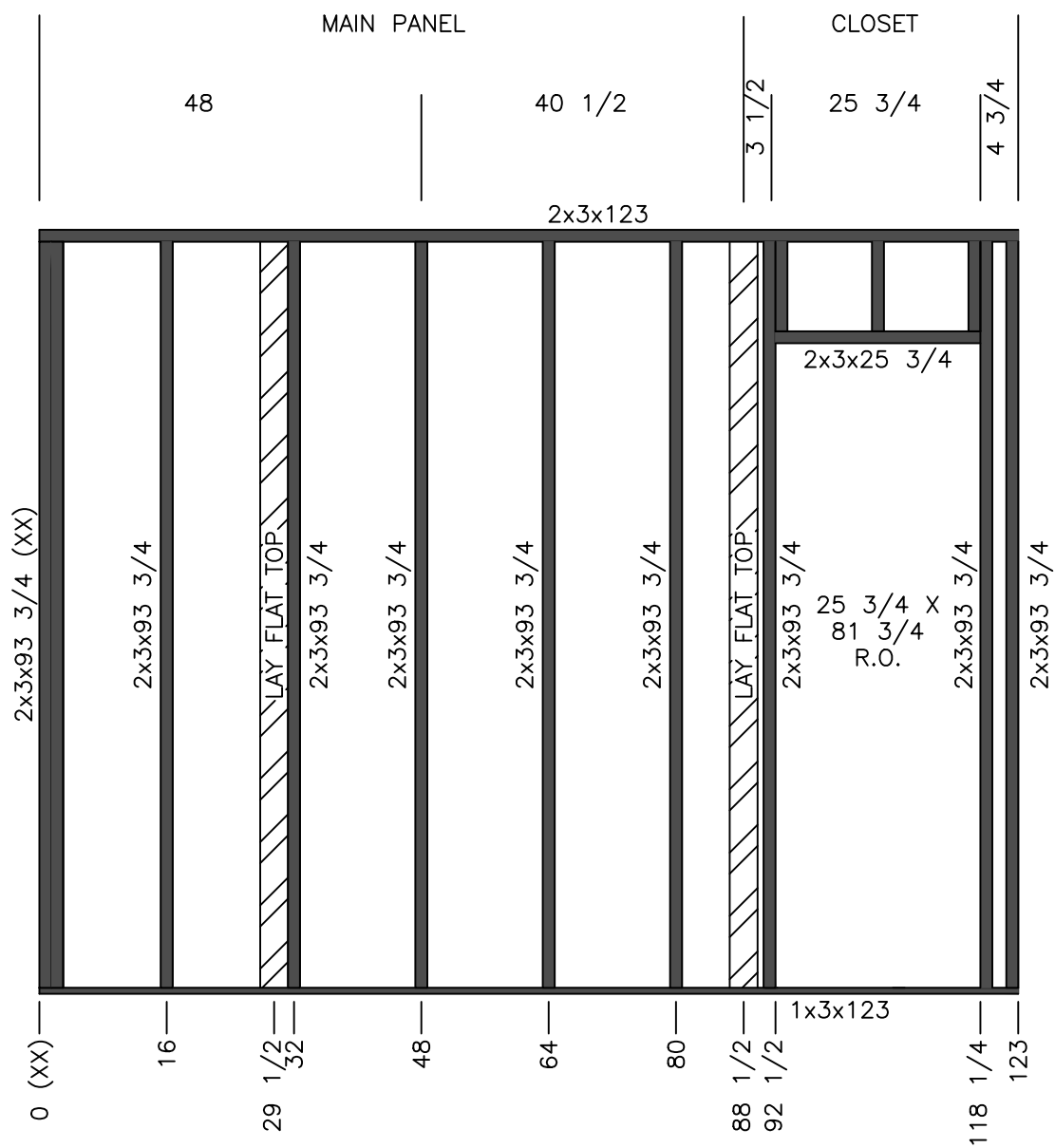

CUTLIST		
QTY	SIZE	TYPE
1	123	1x3
1	123	2x3
10	93 3/4	2x3
2	93 3/4 VLF<U>	1x4

REFERENCE: WALL SET PRINT 34M176 BASE

	MODEL #: EGL28765A	DRAWING #: 34M213
	DATE: 07/05/2023 SCALE: N.T.S.	
PRODUCT DESIGNER: B.K.R.	MODEL: 28' x 76' Eagle	
DESC: WALL 30-A	REV:	

STUD SPACING 24"

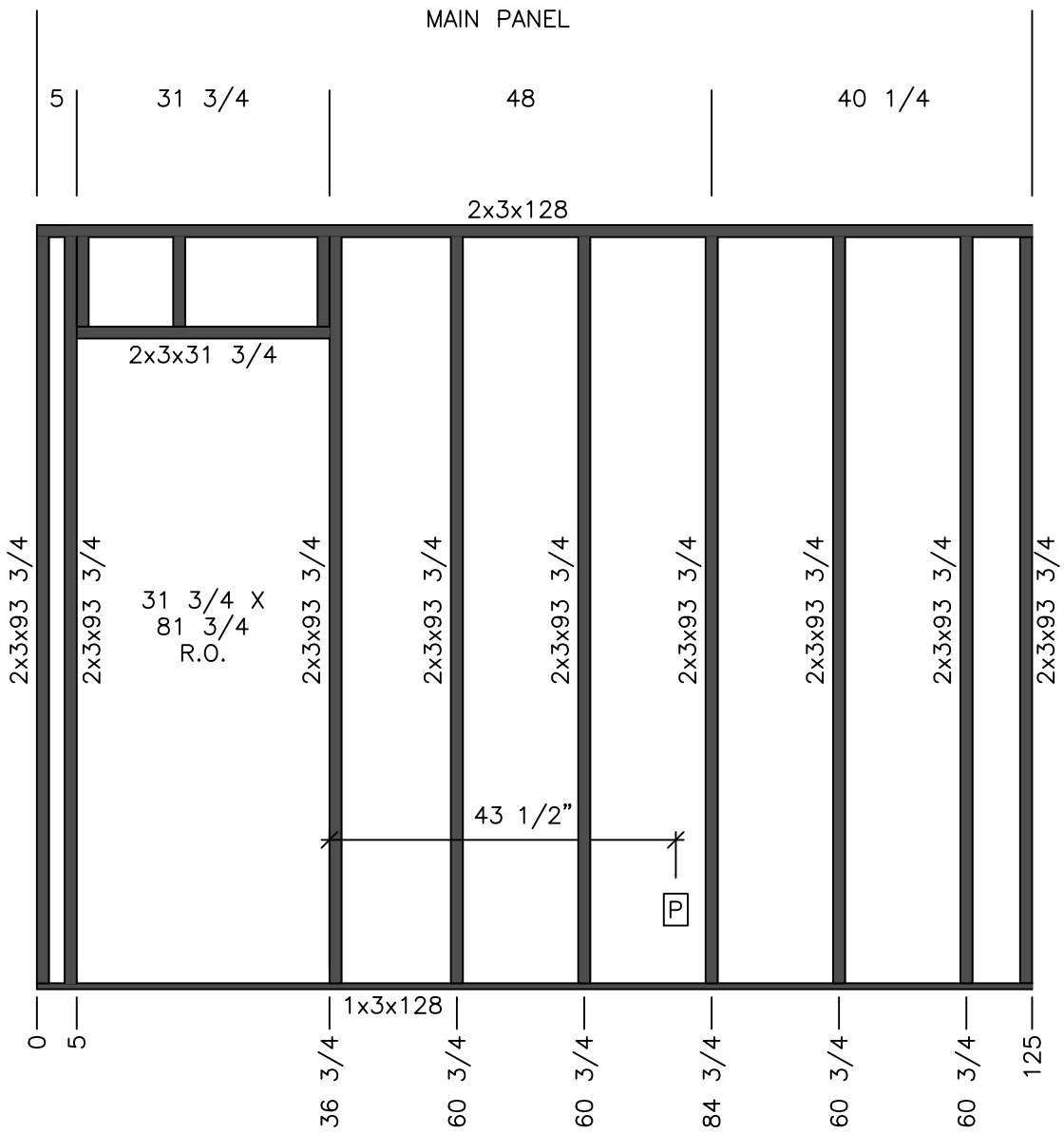

CUTLIST		
QTY	SIZE	TYPE
1	125	1x3
1	125	2x3
7	93 3/4	2x3
1	31 3/4	2x3
3	11 1/4	2x3

REFERENCE: WALL SET PRINT 34M176 BASE

	MODEL #: EGL28765A	DRAWING #: 34M176
	Appalachia - 934	
PRODUCT DESIGNER: D.C.S.	MODEL: 28' x 76' Eagle	
DESC: WALL 30-B	REV: 02/24/2020	

STUD SPACING 24"

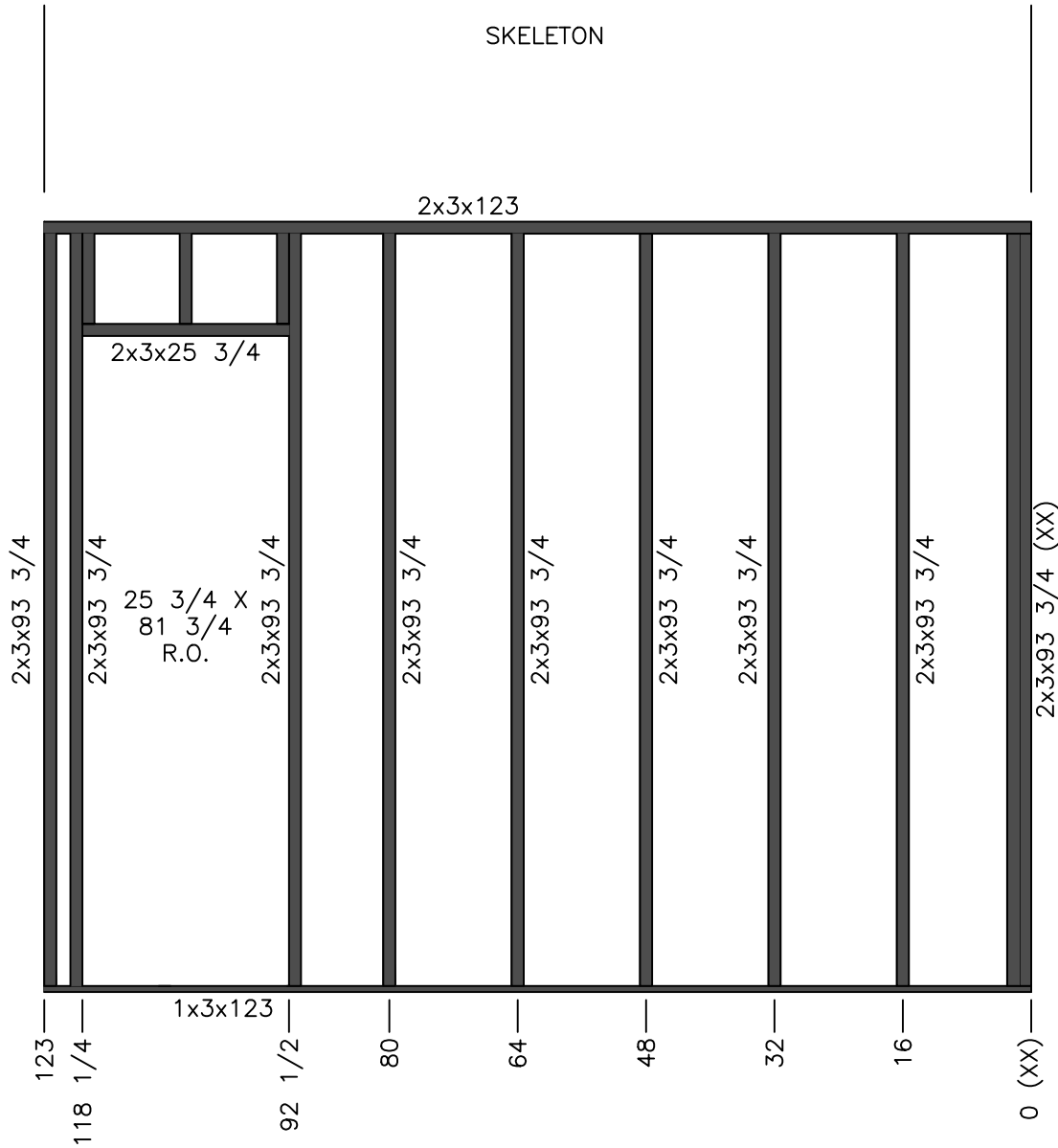

CUTLIST		
QTY	SIZE	TYPE
1	123	1x3
1	123	2x3
10	93 3/4	2x3

REFERENCE: WALL SET PRINT 34M176 BASE

 Appalachia - 934	MODEL #: EGL28765A	DRAWING #: 34M213
	DATE: 07/05/2023 SCALE: N.T.S.	
PRODUCT DESIGNER: B.K.R.	MODEL: 28' x 76' Eagle	
DESC: WALL 31-A		REV:

STUD SPACING 24"

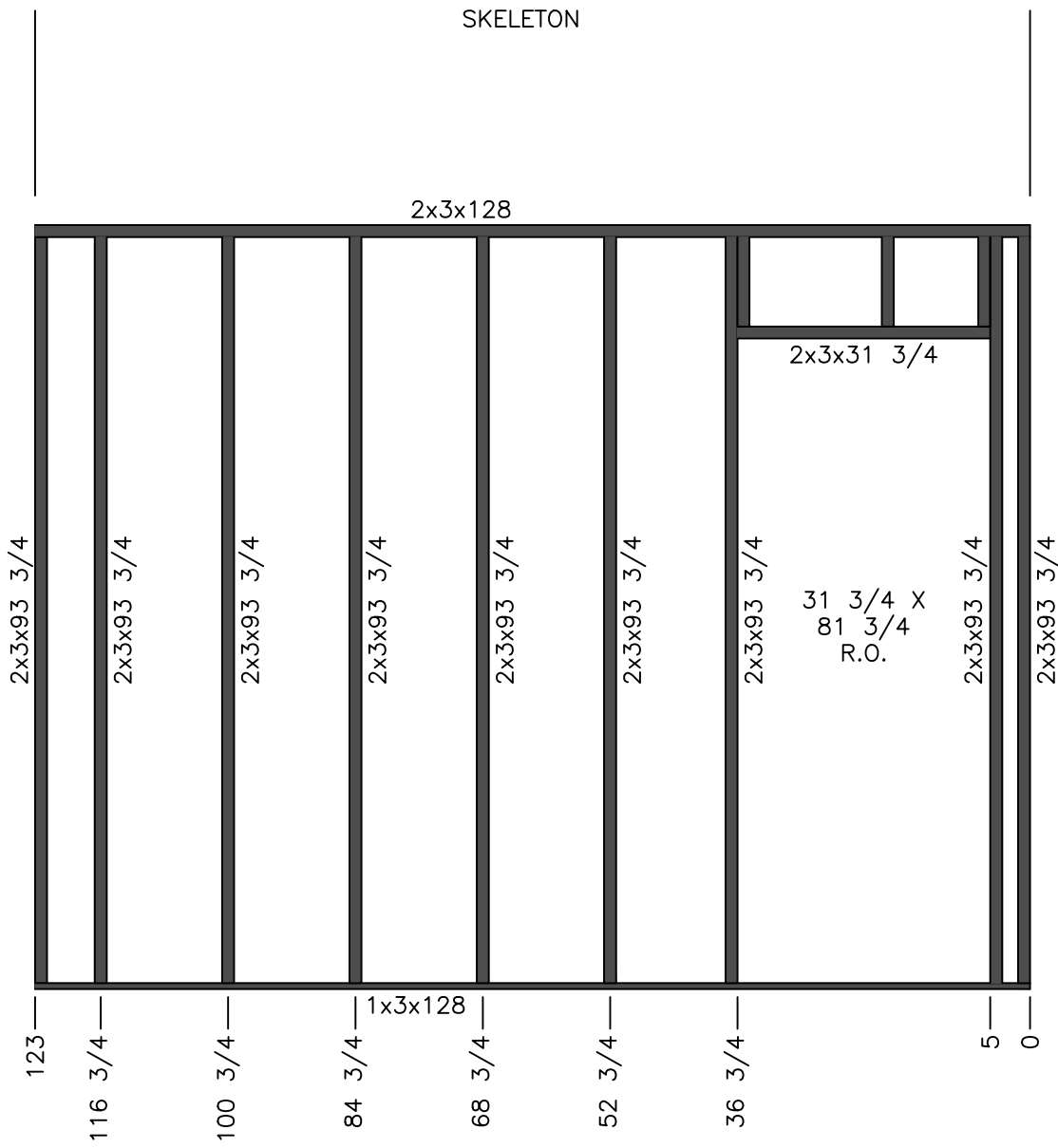

CUTLIST		
QTY	SIZE	TYPE
1	123	1x3
1	123	2x3
9	93 3/4	2x3
1	31 3/4	2x3
3	11 1/4	2x3

REFERENCE: WALL SET PRINT 34M176 BASE

 Appalachia - 934	MODEL #: EGL28765A	DRAWING #: 34M176
	DATE: 01/07/2020 SCALE: N.T.S.	
PRODUCT DESIGNER: D.C.S.	MODEL: 28' x 76' Eagle	
DESC: WALL 31-B	REV: 02/21/2020	

STUD SPACING 24"



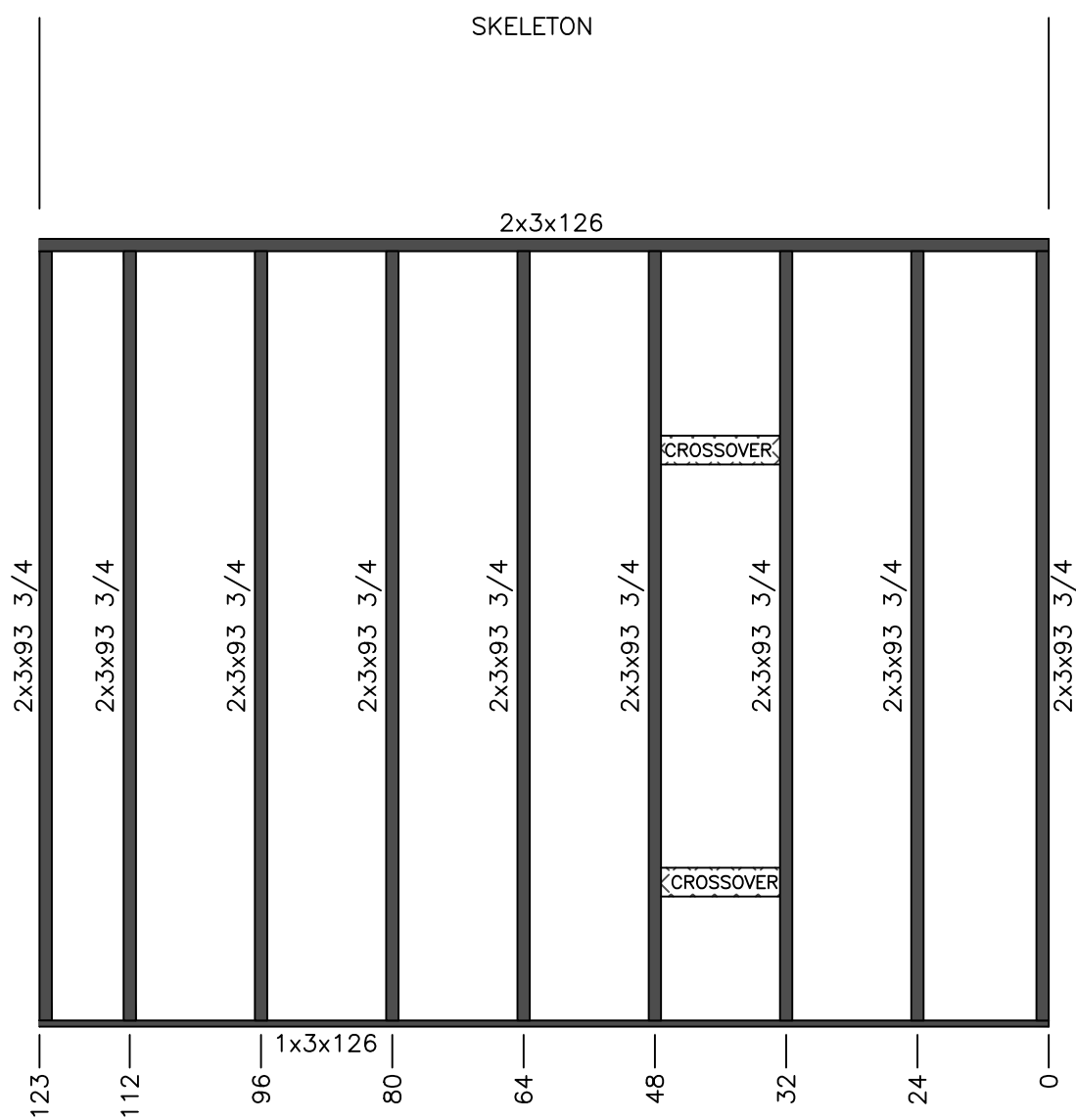

CUTLIST		
QTY	SIZE	TYPE
1	123	1x3
1	123	2x3
7	93 3/4	2x3

REFERENCE: WALL SET PRINT 34M176 BASE

 Appalachia - 934	MODEL #: EGL28765A	DRAWING #: 34M176
	DATE: 01/07/2020 SCALE: N.T.S.	
PRODUCT DESIGNER: D.C.S.	MODEL: 28' x 76' Eagle	
DESC: WALL 32	REV: 02/21/2020	

STUD SPACING 24"

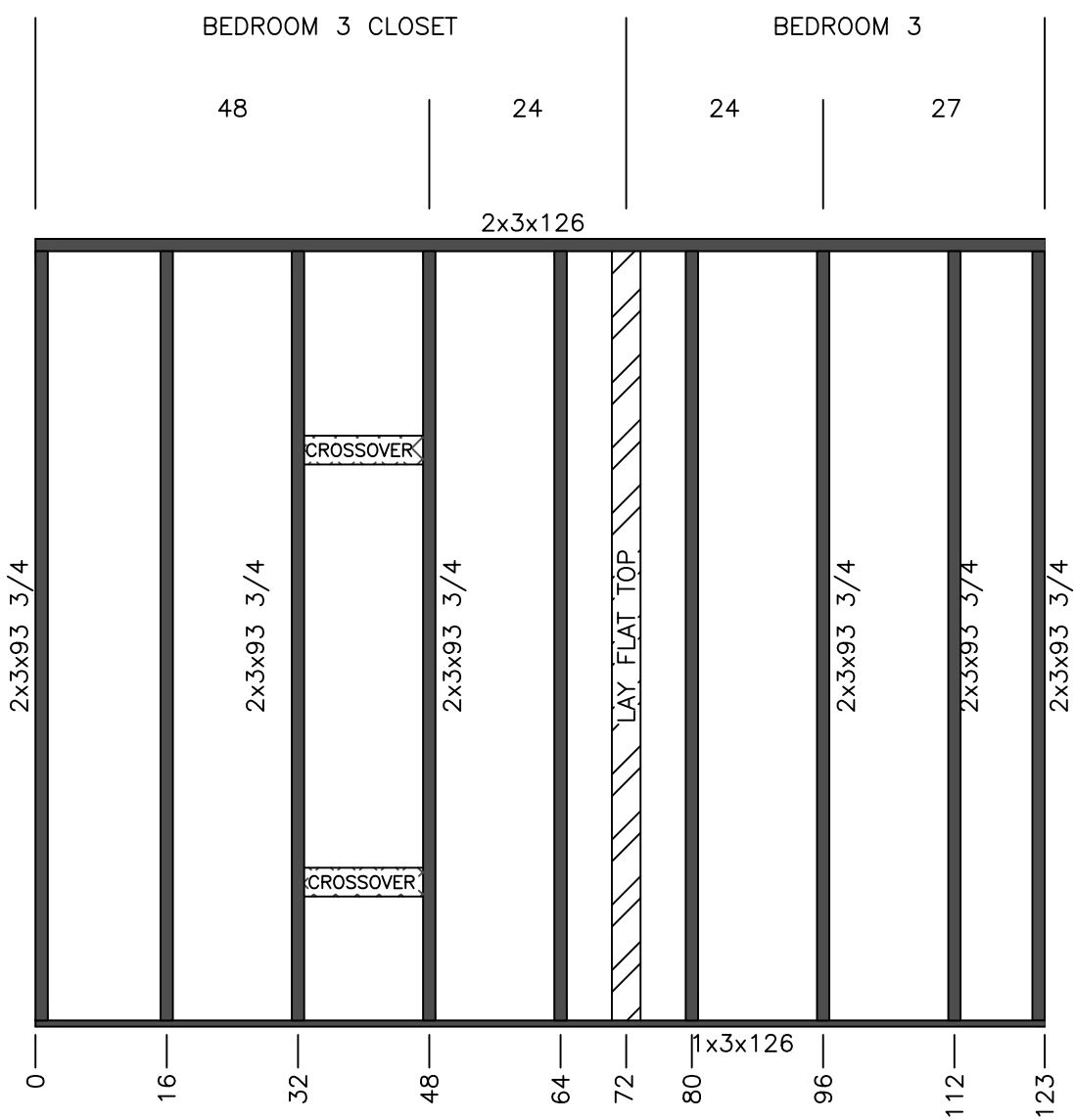

CUTLIST		
QTY	SIZE	TYPE
1	123	1x3
1	123	2x3
7	93 3/4	2x3
1	93 3/4 VLF<U>	1x4

REFERENCE: WALL SET PRINT 34M176 BASE

	MODEL #: EGL28765A	DRAWING #: 34M176
	DATE: 01/07/2020 SCALE: N.T.S.	
PRODUCT DESIGNER: D.C.S.	MODEL: 28' x 76' Eagle	
DESC: WALL 33	REV: 02/21/2020	

STUD SPACING 24"

CUTLIST		
QTY	SIZE	TYPE
1	154	1x3
1	154	2x3
11	93 3/4	2x3

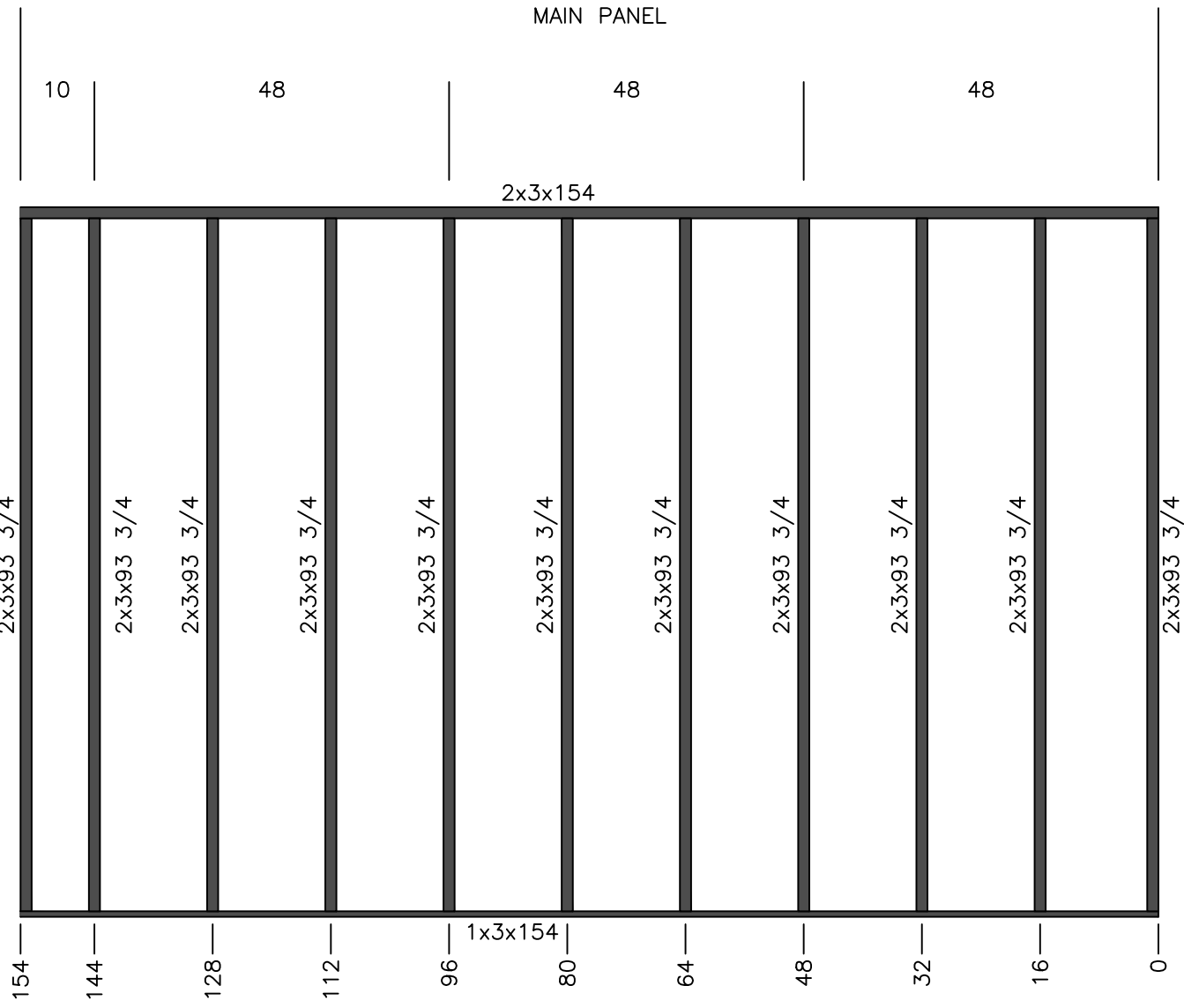

REFERENCE: WALL SET PRINT 34M176 BASE

		MODEL #: EGL28765A	DRAWING #: <b>34M176</b>
		DATE: 01/07/2020 SCALE: N.T.S.	
PRODUCT DESIGNER: D.C.S.	MODEL: <b>28' x 76' Eagle</b>		
DESC: <b>WALL 34</b>		REV:	

STUD SPACING 16"

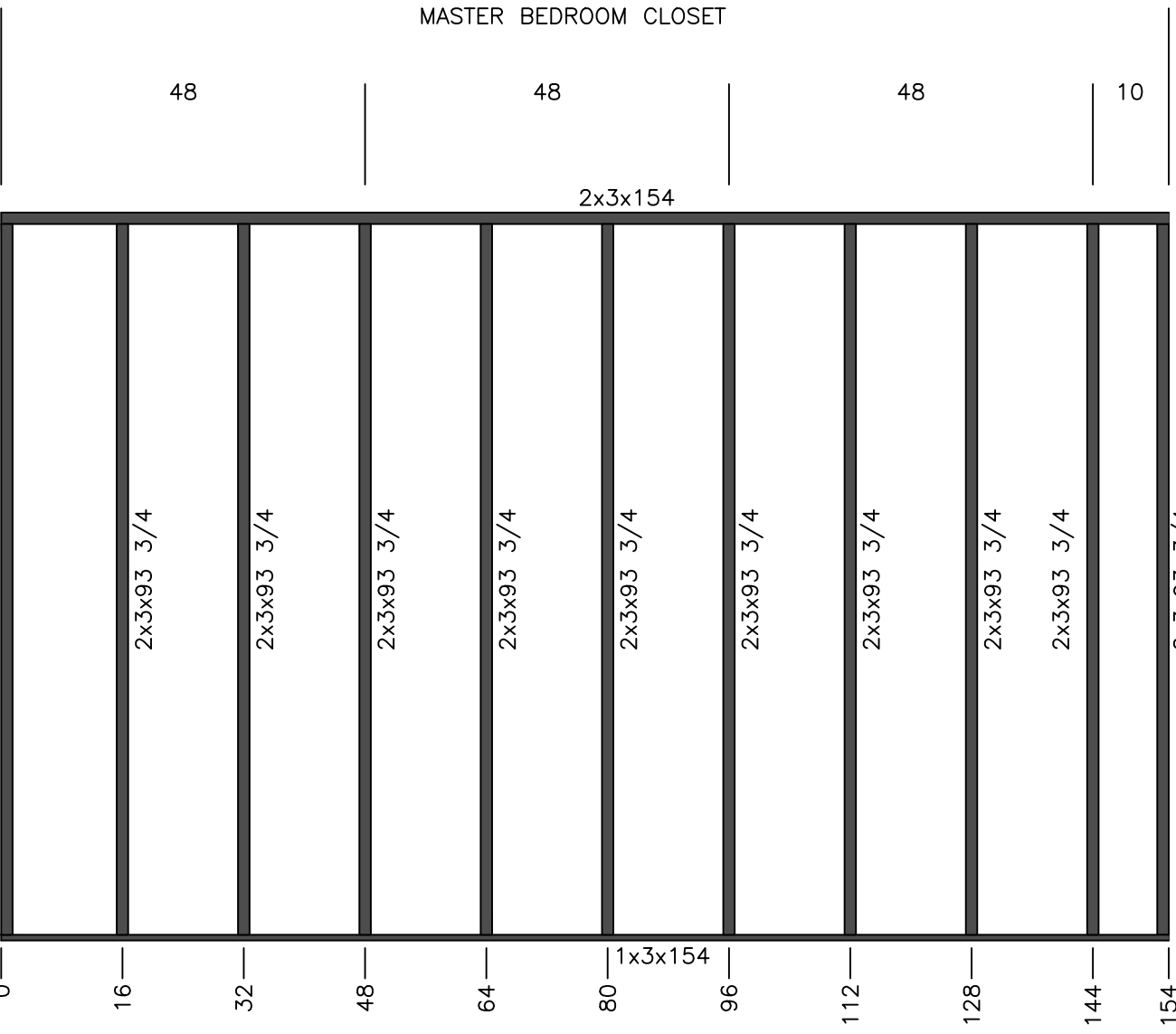

MASTER BEDROOM CLOSET

CUTLIST

QTY	SIZE	TYPE
1	154	1x3
1	154	2x3
11	93 3/4	2x3

REFERENCE: WALL SET PRINT 34M176 BASE

		MODEL #: EGL28765A	DRAWING #: <b>34M176</b>
		DATE: 01/07/2020 SCALE: N.T.S.	
PRODUCT DESIGNER: D.C.S.	MODEL: 28' x 76' Eagle		
DESC: WALL 35		REV:	

STUD SPACING 16"

CUTLIST		
QTY	SIZE	TYPE
1	154	1x3
1	154	2x3
11	93 3/4	2x3

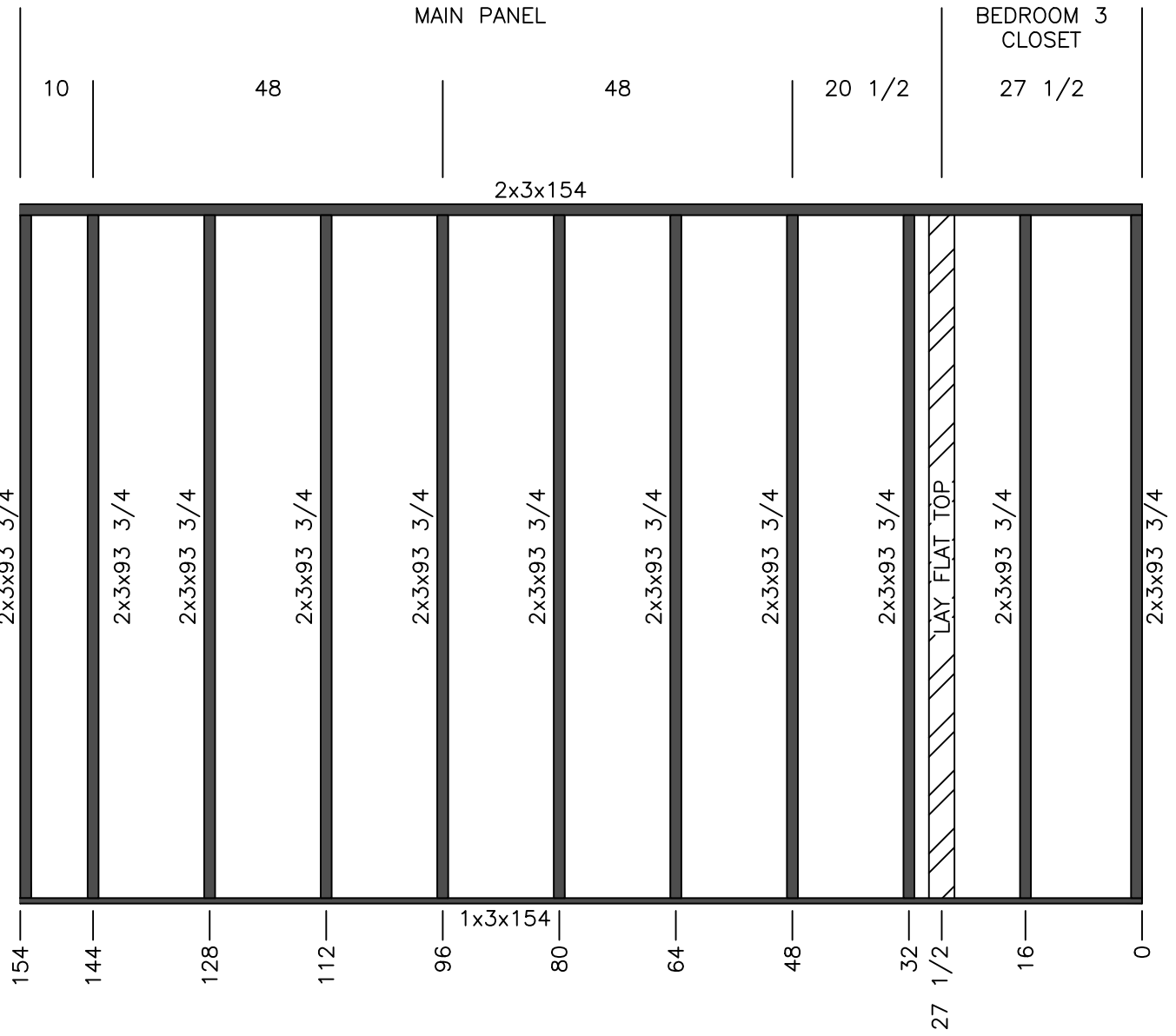

REFERENCE: WALL SET PRINT 34M176 BASE

		MODEL #: EGL28765A	DRAWING #: <b>34M176</b>
		DATE: 01/07/2020 SCALE: N.T.S.	
PRODUCT DESIGNER: D.C.S.	MODEL: <b>28' x 76' Eagle</b>		
DESC: <b>WALL 36</b>		REV:	

STUD SPACING 16"

CUTLIST		
QTY	SIZE	TYPE
1	154	1x3
1	154	2x3
11	93 3/4	2x3

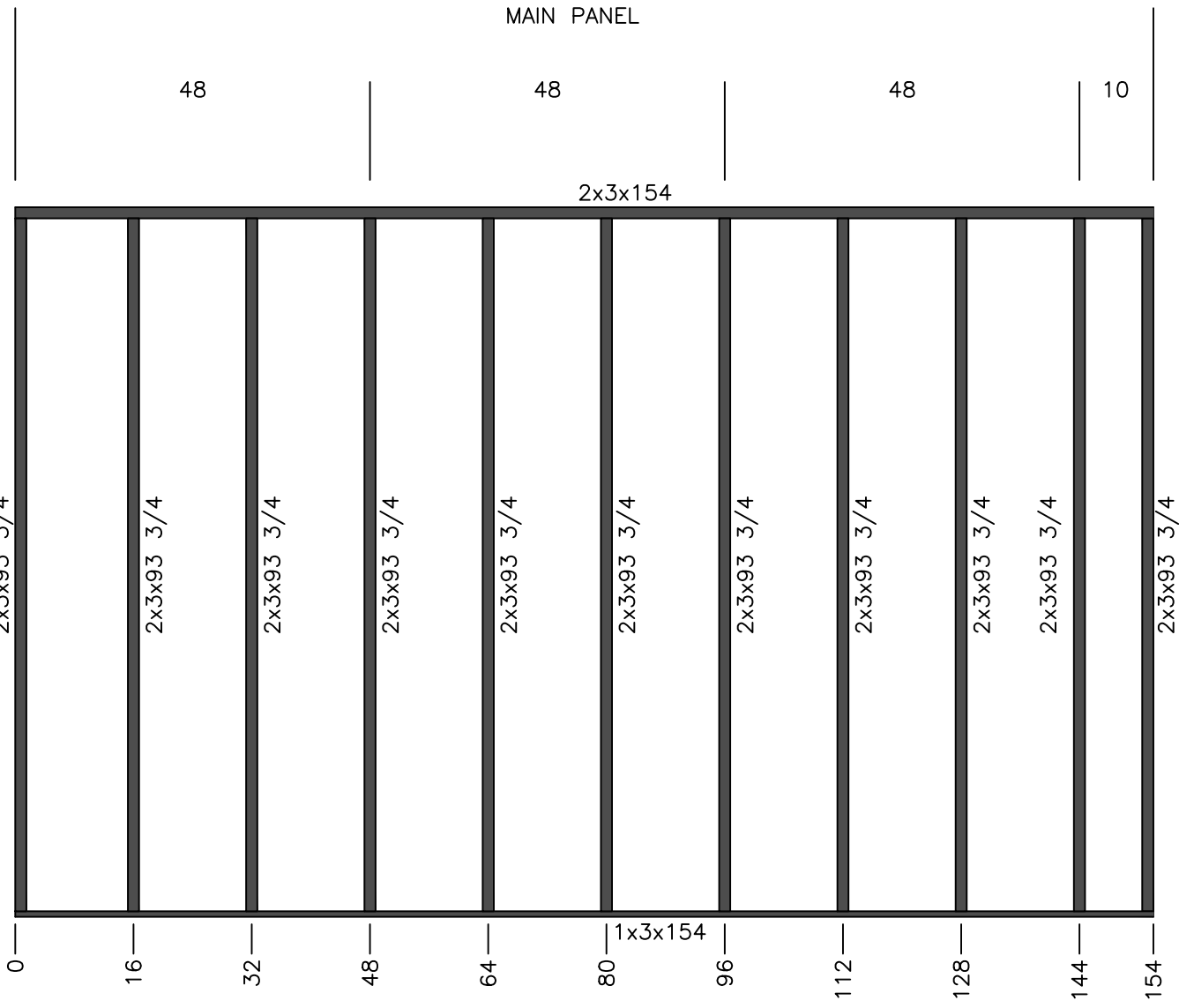

REFERENCE: WALL SET PRINT 34M176 BASE

		MODEL #: EGL28765A	DRAWING #: <b>34M176</b>
		DATE: 01/07/2020 SCALE: N.T.S.	
PRODUCT DESIGNER: D.C.S.	MODEL: <b>28' x 76' Eagle</b>		
DESC: <b>WALL 37</b>		REV:	

STUD SPACING 16"

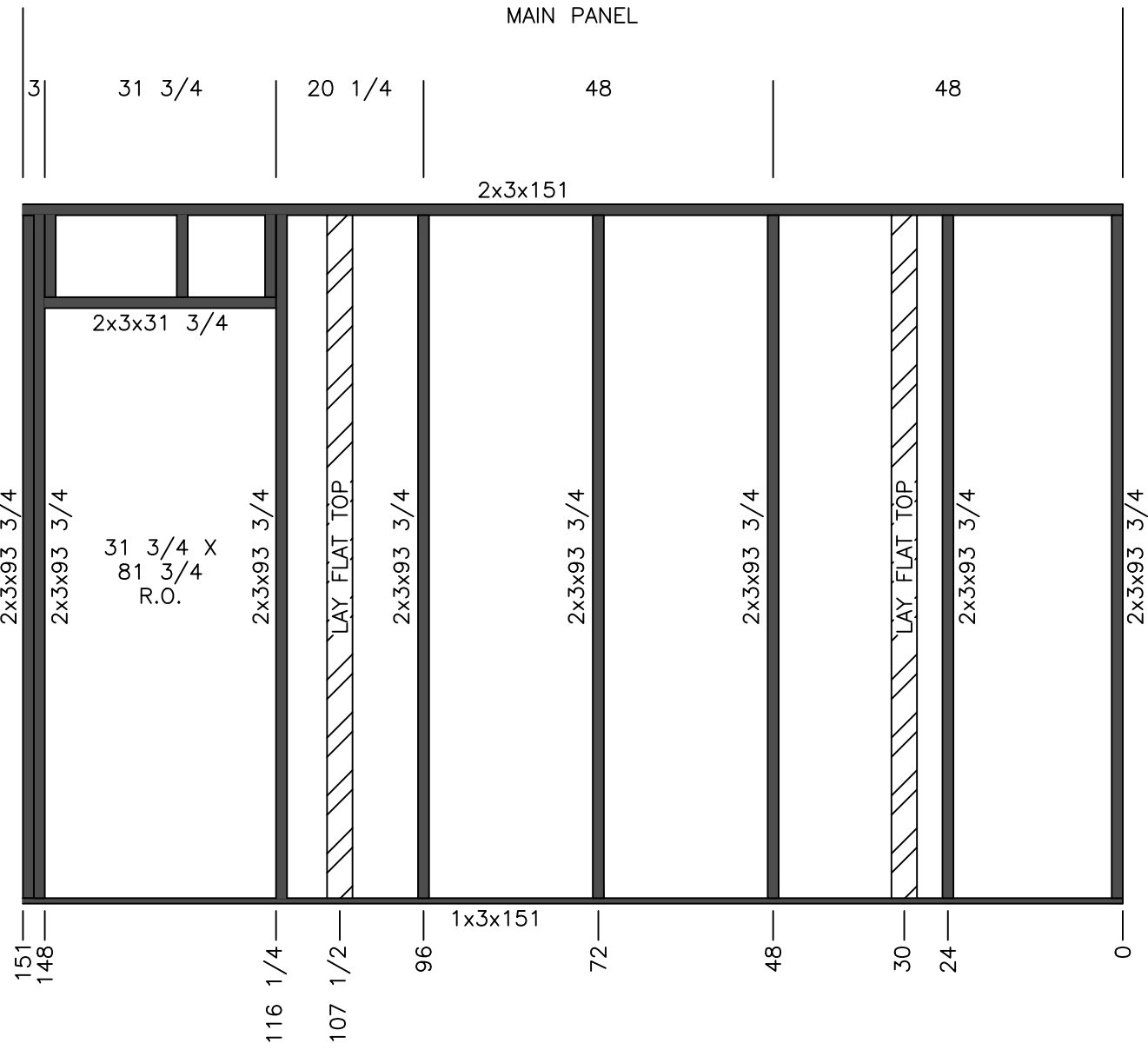

CUTLIST		
QTY	SIZE	TYPE
1	151	1x3
1	151	2x3
8	93 3/4	2x3
1	31 3/4	2x3
3	11 1/4	2x3
2	93 3/4 VLF<U>	1x4

REFERENCE: WALL SET PRINT 34M176 BASE

 Appalachia - 934	MODEL #: EGL28765A	DRAWING #: 34M176
	DATE: 01/07/2020 SCALE: N.T.S.	
PRODUCT DESIGNER: D.C.S.	MODEL: 28' x 76' Eagle	
DESC: WALL 38		REV:

STUD SPACING 24"

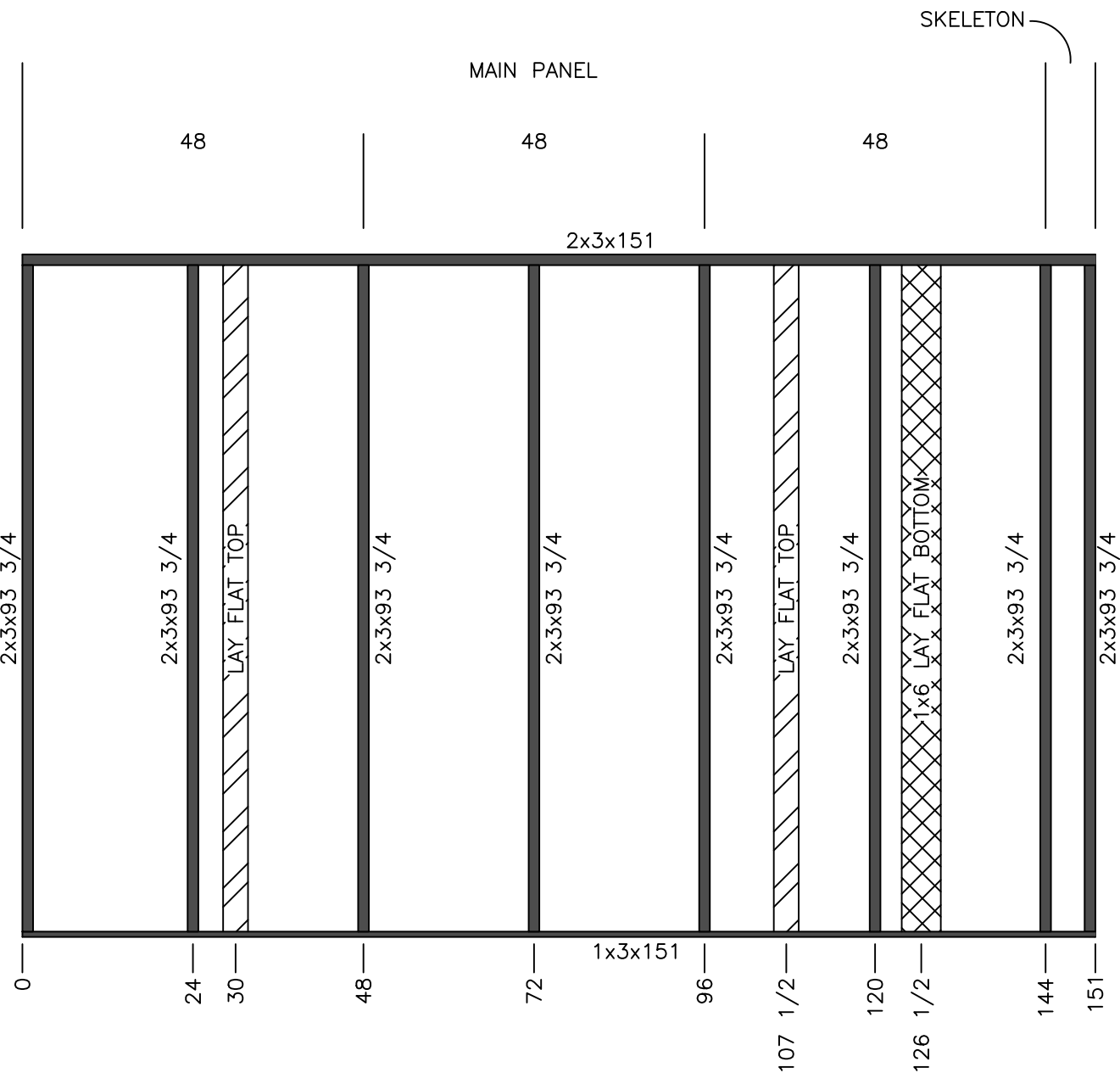

CUTLIST		
QTY	SIZE	TYPE
1	151	1x3
1	151	2x3
8	93 3/4	2x3
2	93 3/4 VLF<U>	1x4
1	93 3/4 VLF<D>	1x6

REFERENCE: WALL SET PRINT 34M176 BASE

 Appalachia - 934	MODEL #: EGL28765A	DRAWING #: <b>34M176</b>
	DATE: 01/07/2020 SCALE: N.T.S.	
PRODUCT DESIGNER: D.C.S.	MODEL: <b>28' x 76' Eagle</b>	
DESC: <b>WALL 39</b>		REV:

STUD SPACING 24"



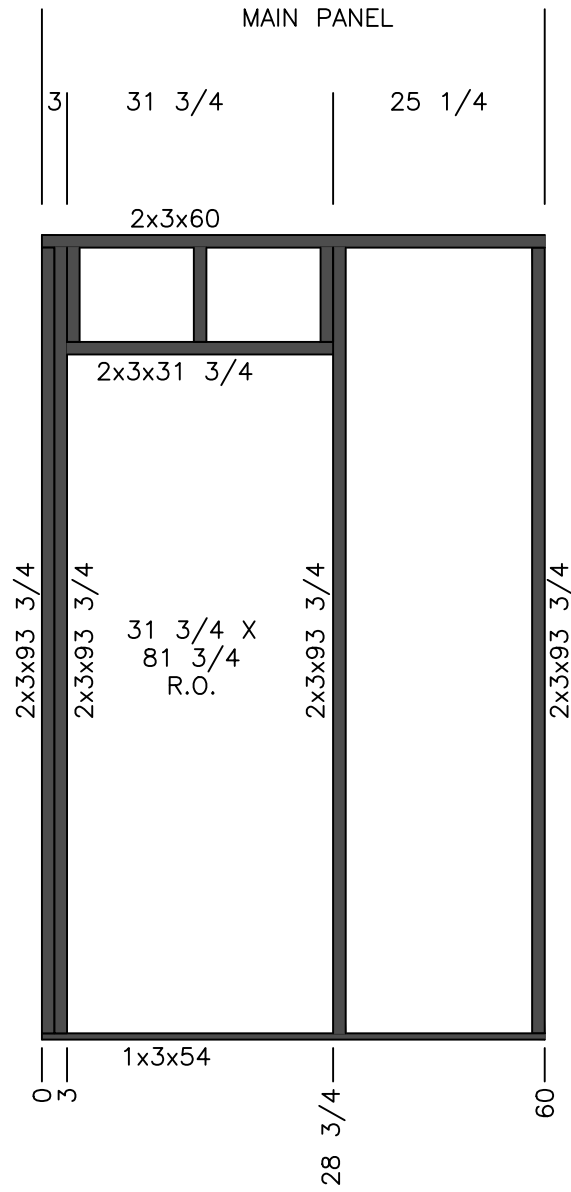

CUTLIST		
QTY	SIZE	TYPE
1	60	1x3
1	60	2x3
4	93 3/4	2x3
1	31 3/4	2x3
3	11 1/4	2x3

REFERENCE: WALL SET PRINT 34M176 BASE

 <b>Clayton</b> Appalachia - 934	MODEL #: EGL28765A	DRAWING #: <b>34M176</b>
	DATE: 01/07/2020 SCALE: N.T.S.	
PRODUCT DESIGNER: D.C.S.	MODEL: <b>28' x 76' Eagle</b>	
DESC: <b>WALL 40</b>	REV:	

STUD SPACING 24"

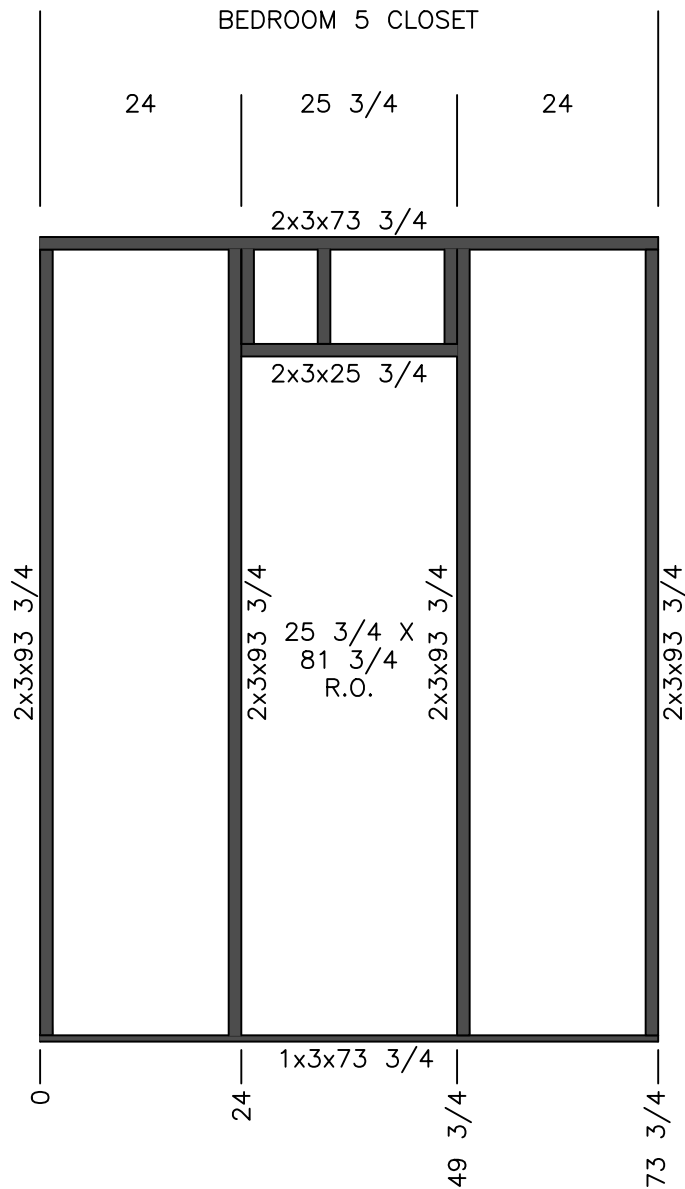

CUTLIST		
QTY	SIZE	TYPE
1	73 3/4	1x3
1	73 3/4	2x3
4	93 3/4	2x3
1	25 3/4	2x3
3	11 1/4	2x3

REFERENCE: WALL SET PRINT 34M176 BASE

<b>Clayton</b> Appalachia - 934	MODEL #: EGL28765A	DRAWING #: <b>34M176</b>
	DATE: 01/07/2020 SCALE: N.T.S.	
PRODUCT DESIGNER: D.C.S.	MODEL: 28' x 76' Eagle	
DESC: WALL 41		REV:

STUD SPACING 24"

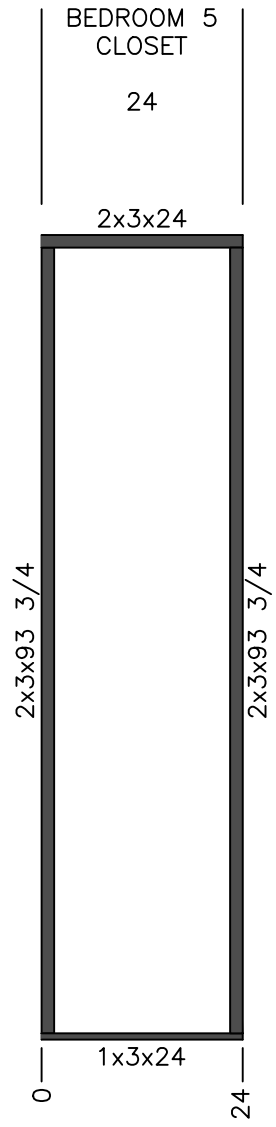

CUTLIST		
QTY	SIZE	TYPE
1	24	1x3
1	24	2x3
2	93 3/4	2x3

REFERENCE: WALL SET PRINT 34M176 BASE

	MODEL #: EGL28765A	DRAWING #: 34M176
	DATE: 01/07/2020 SCALE: N.T.S.	
PRODUCT DESIGNER: D.C.S.	MODEL: 28' x 76' Eagle	
DESC: WALL 42		REV:

STUD SPACING 24"

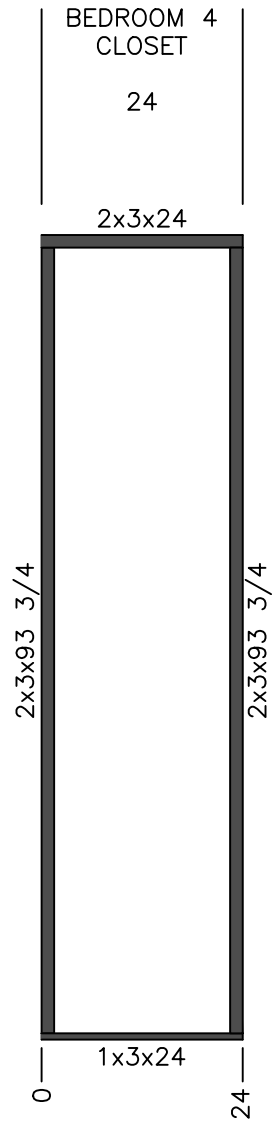

CUTLIST		
QTY	SIZE	TYPE
1	24	1x3
1	24	2x3
2	93 3/4	2x3

REFERENCE: WALL SET PRINT 34M176 BASE

 Appalachia - 934	MODEL #: EGL28765A	DRAWING #: 34M176
	DATE: 01/07/2020 SCALE: N.T.S.	
PRODUCT DESIGNER: D.C.S.	MODEL: 28' x 76' Eagle	
DESC: WALL 43		REV:

STUD SPACING 24"

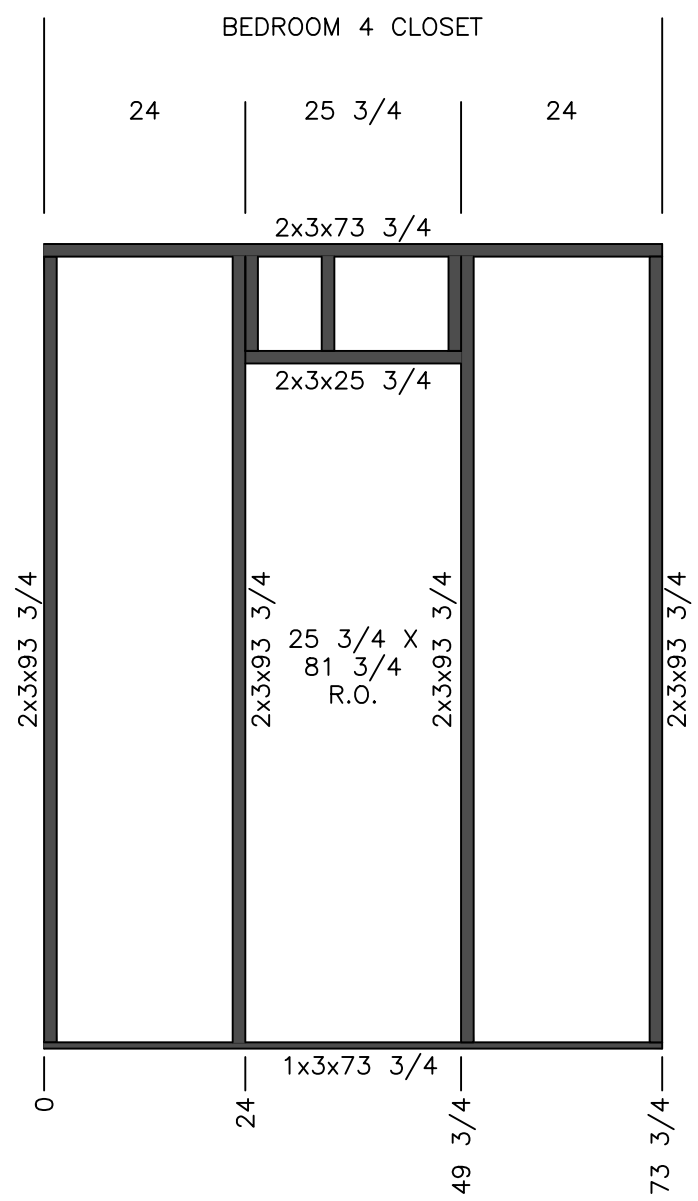

CUTLIST		
QTY	SIZE	TYPE
1	73 3/4	1x3
1	73 3/4	2x3
4	93 3/4	2x3
1	25 3/4	2x3
3	11 1/4	2x3

REFERENCE: WALL SET PRINT 34M176 BASE

	MODEL #: EGL28765A	DRAWING #: 34M176
	DATE: 01/07/2020 SCALE: N.T.S.	
PRODUCT DESIGNER: D.C.S.	MODEL: 28' x 76' Eagle	
DESC: WALL 44		REV:

STUD SPACING 24"

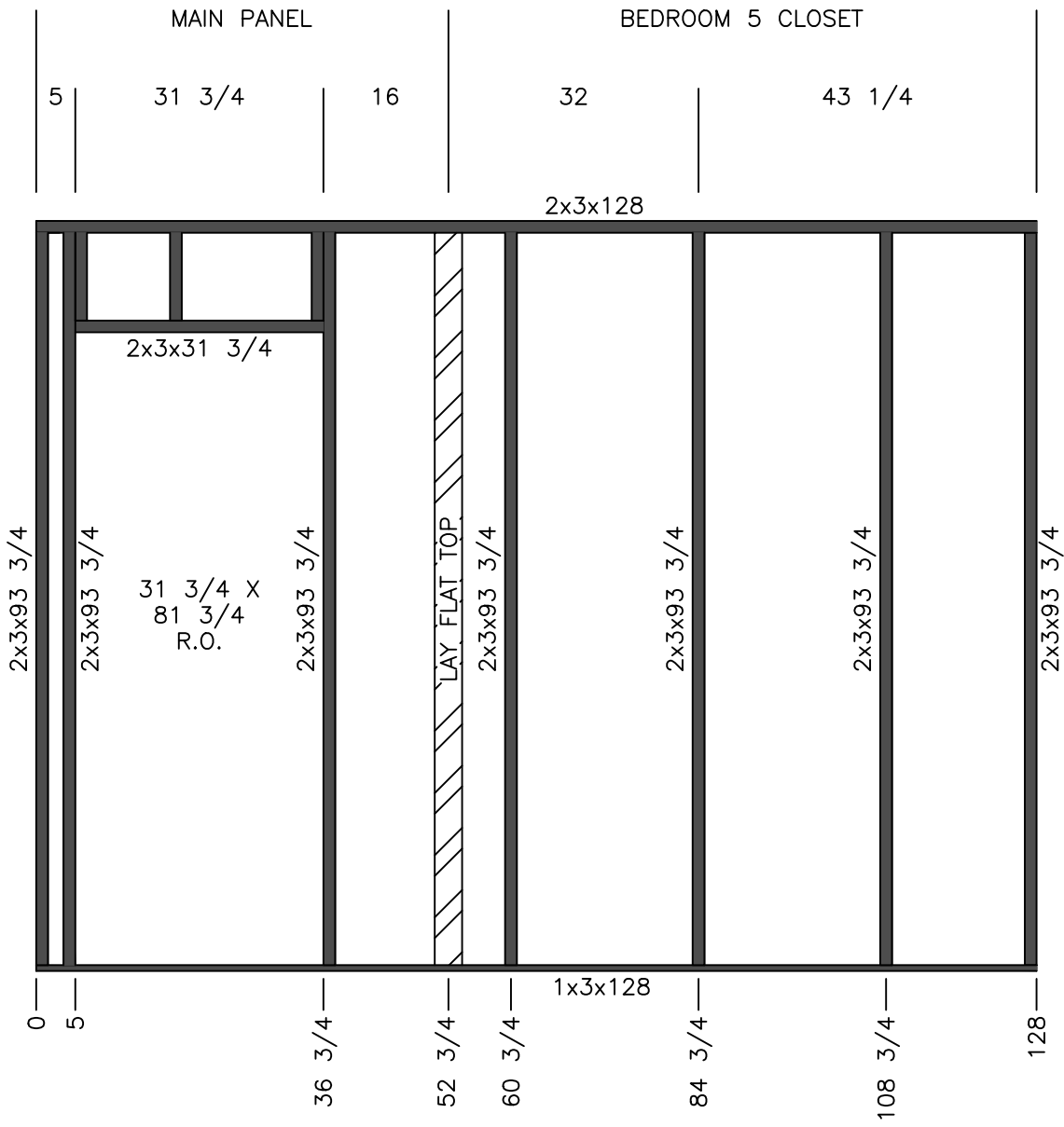

CUTLIST		
QTY	SIZE	TYPE
1	128	1x3
1	128	2x3
7	93 3/4	2x3
1	31 3/4	2x3
3	11 1/4	2x3
1	93 3/4 VLF<U>	1x4

REFERENCE: WALL SET PRINT 34M176 BASE

 Appalachia - 934	MODEL #: EGL28765A	DRAWING #: 34M176
	DATE: 01/07/2020 SCALE: N.T.S.	
PRODUCT DESIGNER: D.C.S.	MODEL: 28' x 76' Eagle	
DESC: WALL 45	REV: 02/21/2020	

STUD SPACING 24"

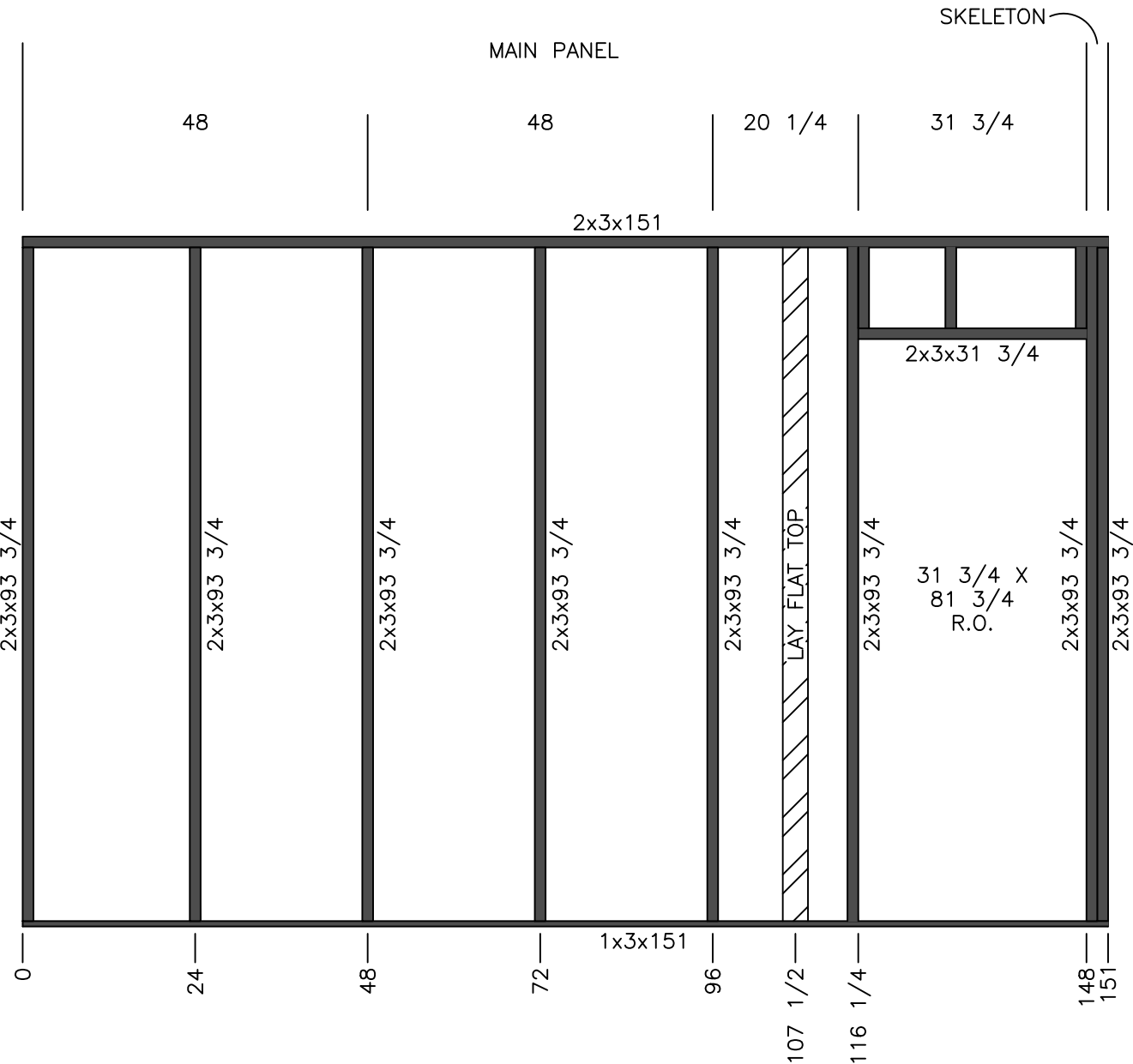

CUTLIST		
QTY	SIZE	TYPE
1	151	1x3
1	151	2x3
8	93 3/4	2x3
1	31 3/4	2x3
3	11 1/4	2x3
1	93 3/4 VLF<U>	1x4

REFERENCE: WALL SET PRINT 34M176 BASE

 Appalachia - 934	MODEL #: EGL28765A	DRAWING #: 34M176
	DATE: 01/07/2020 SCALE: N.T.S.	
PRODUCT DESIGNER: D.C.S.	MODEL: 28' x 76' Eagle	
DESC: WALL 46		REV:

STUD SPACING 24"

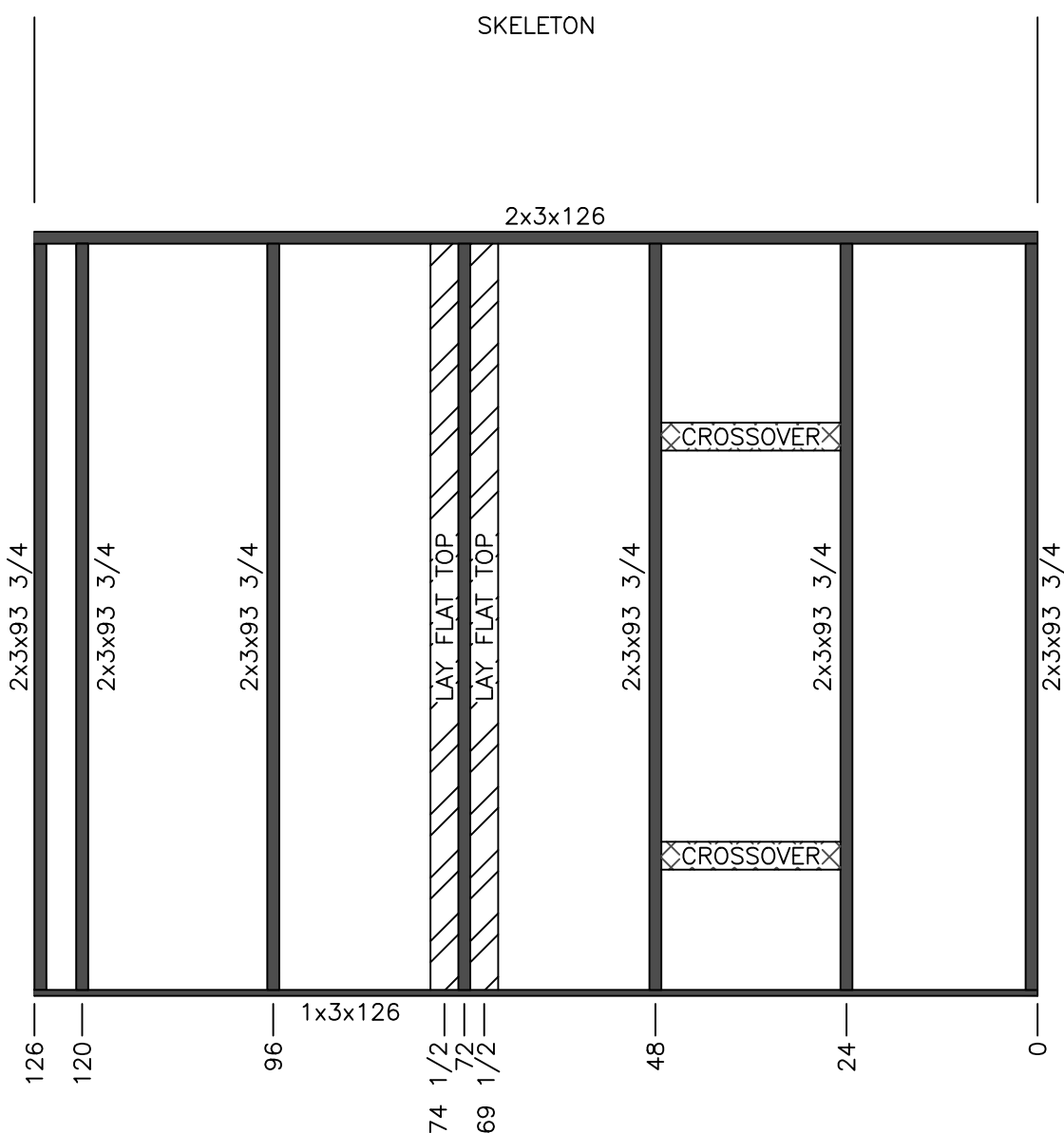

CUTLIST		
QTY	SIZE	TYPE
1	126	1x3
1	126	2x3
7	93 3/4	2x3
2	93 3/4 VLF<U>	1x4

REFERENCE: WALL SET PRINT 34M176 BASE

	MODEL #: EGL28765A	DRAWING #: 34M176
	DATE: 01/07/2020 SCALE: N.T.S.	
PRODUCT DESIGNER: D.C.S.	MODEL: 28' x 76' Eagle	
DESC: WALL 47	REV: 02/21/2020	

STUD SPACING 24"



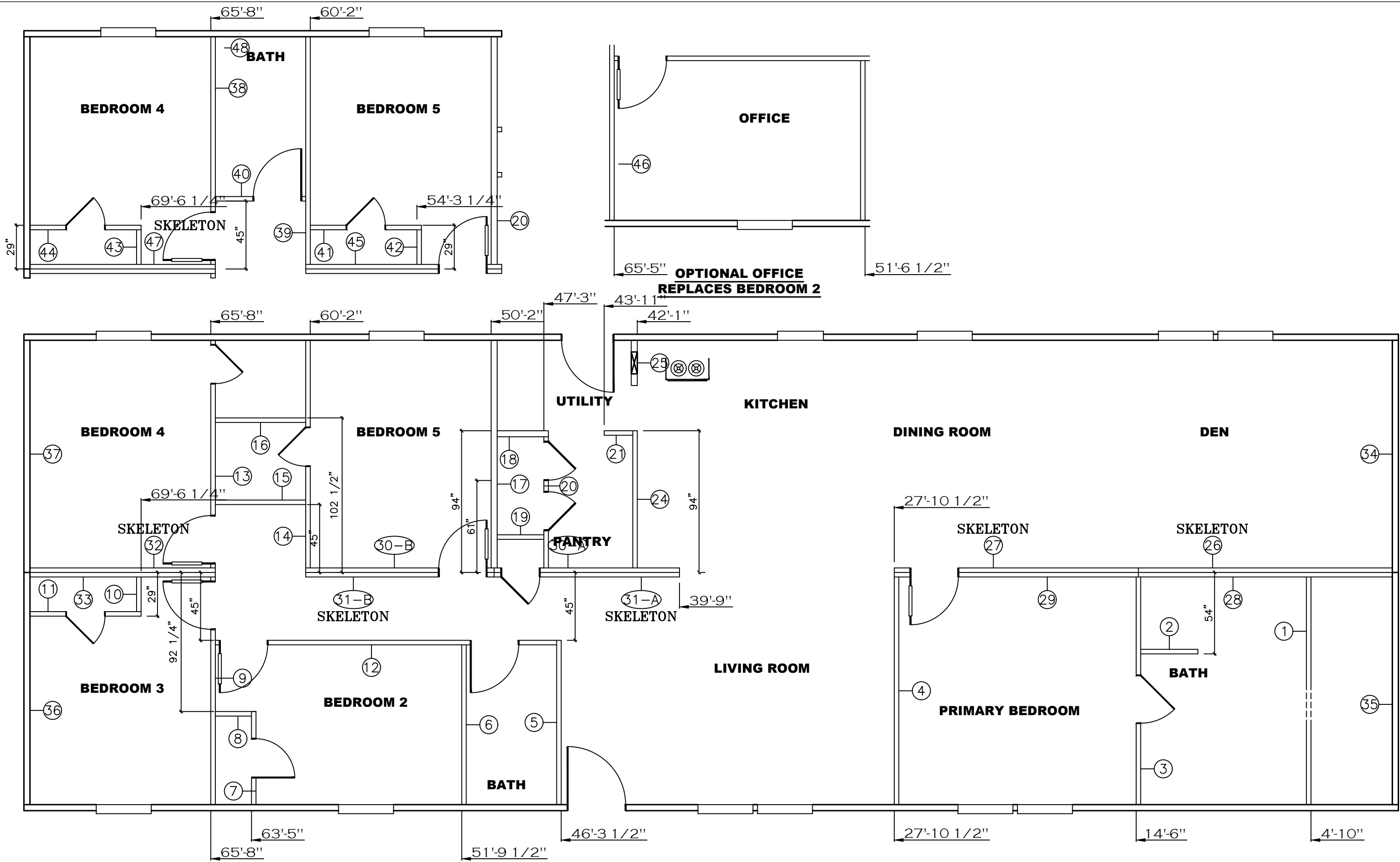

REVISION	DATE	DESCRIPTION	REVISION	DATE	DESCRIPTION

SHEET:  
BASE

WALL SET PLAN

**Clayton** Clayton - 934  
1420 Mountain Rd, Andersonville, TN 37705  
PH: 865.494.7800 FAX: 865.494.0243

HILBORN, WERNER, CARTER,  
AND ASSOCIATES, INC.  
1627 SOUTH MYRTLE AVE.  
CLEARWATER, FL. 33756

DRAWING # 34M213  
MODEL # EGL28765A  
DATE: 07/05/2023 SCALE: N.T.S.

MODEL: THE EAGLE 76 (28'x76")  
SERIES: EAGLE SERIES  
PRODUCT DESIGNER: BRIAN K. RIFFEY

STD PLAN "CONDITIONED":  
2,001 FT<sup>2</sup>  
REV. BY:  
REV. DATE:

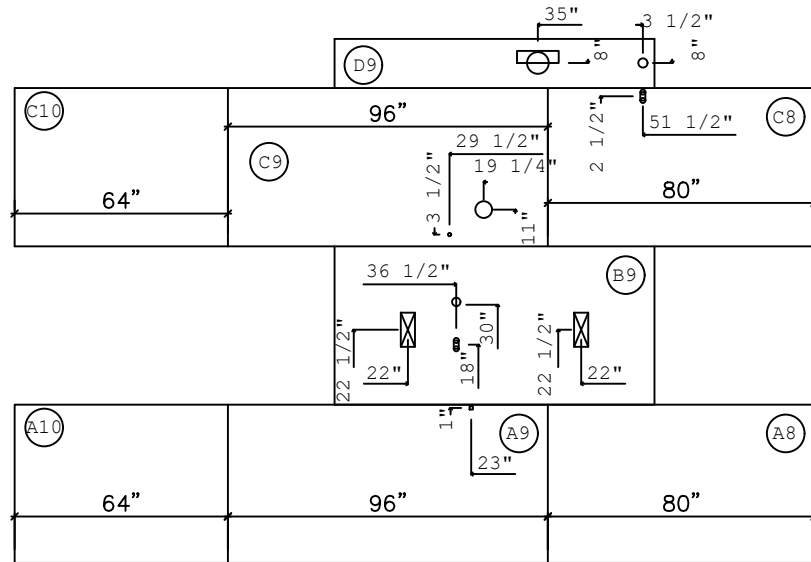

OPT. 3RD BATH

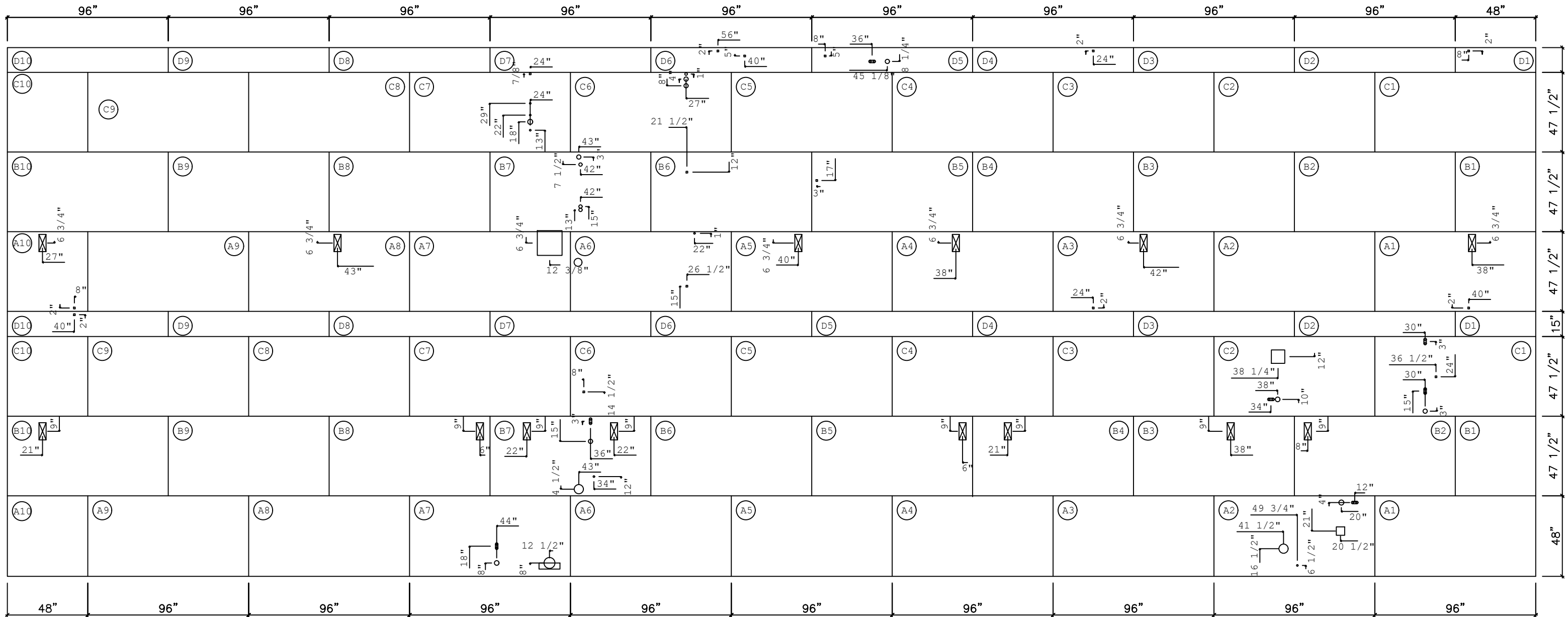

14 3/4"

REVISION	DATE	DESCRIPTION	REVISION	DATE	DESCRIPTION

SHEET:  
DECK

FLOOR DECKING LAYOUT

**Clayton** Clayton - 934  
1420 Mountain Rd, Andersonville, TN 37705  
PH: 865.494.7800 FAX: 865.494.0243

HILBORN, WERNER, CARTER,  
AND ASSOCIATES, INC.  
1627 SOUTH MYRTLE AVE.  
CLEARWATER, FL. 33756

DRAWING # 34M213  
MODEL # EGL28765A  
DATE: 07/05/2023 SCALE: N.T.S.

MODEL: THE EAGLE 76 (28'x76')  
SERIES: EAGLE SERIES  
PRODUCT DESIGNER: BRIAN K. RIFFEY

STD PLAN "CONDITIONED": 2,001 FT<sup>2</sup>  
REV. BY:  
REV. DATE:

HALL BATH

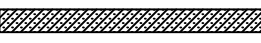
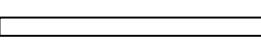
D.W.V. LINE SIZE CHART	
	= 3"
	= 2"
	= 1 1/2"

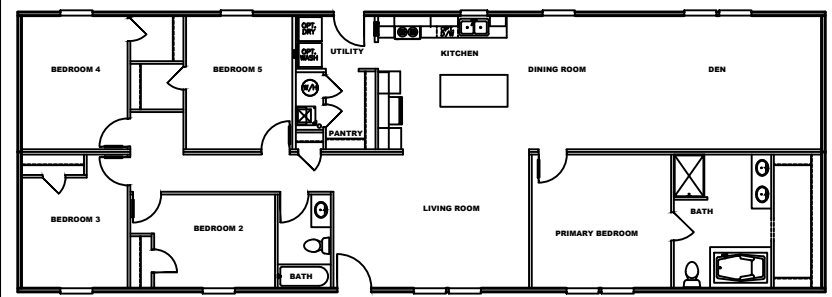
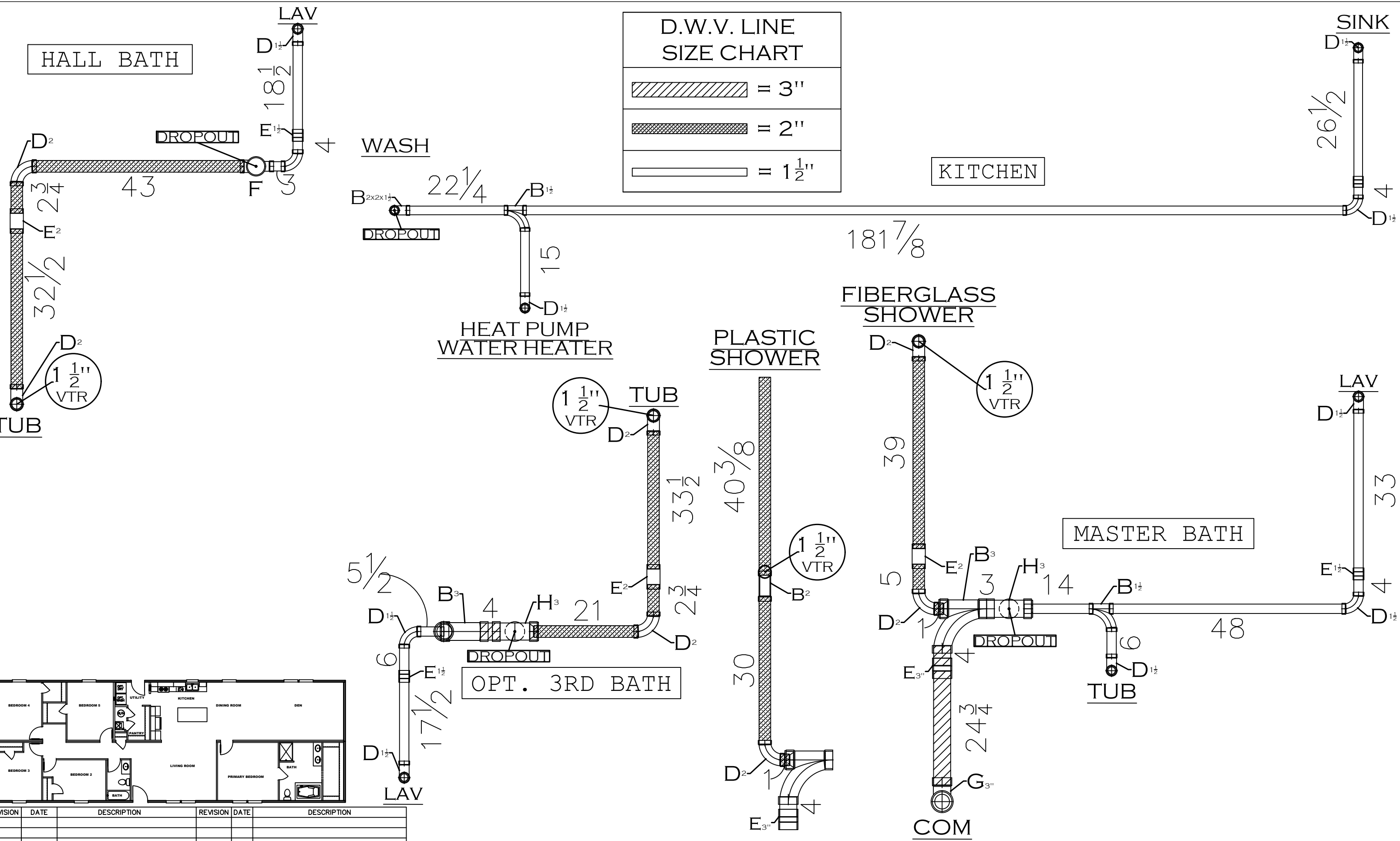

REVISION	DATE	DESCRIPTION	REVISION	DATE	DESCRIPTION

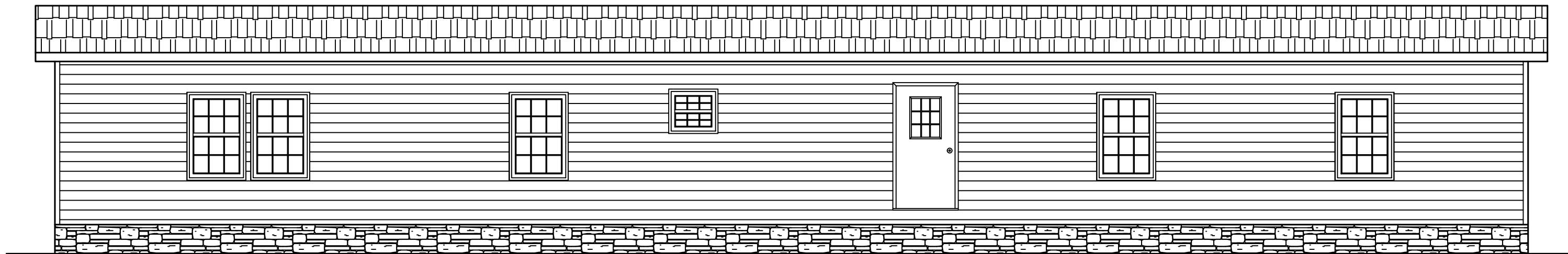

76'-0"  
**REAR ELEVATION**

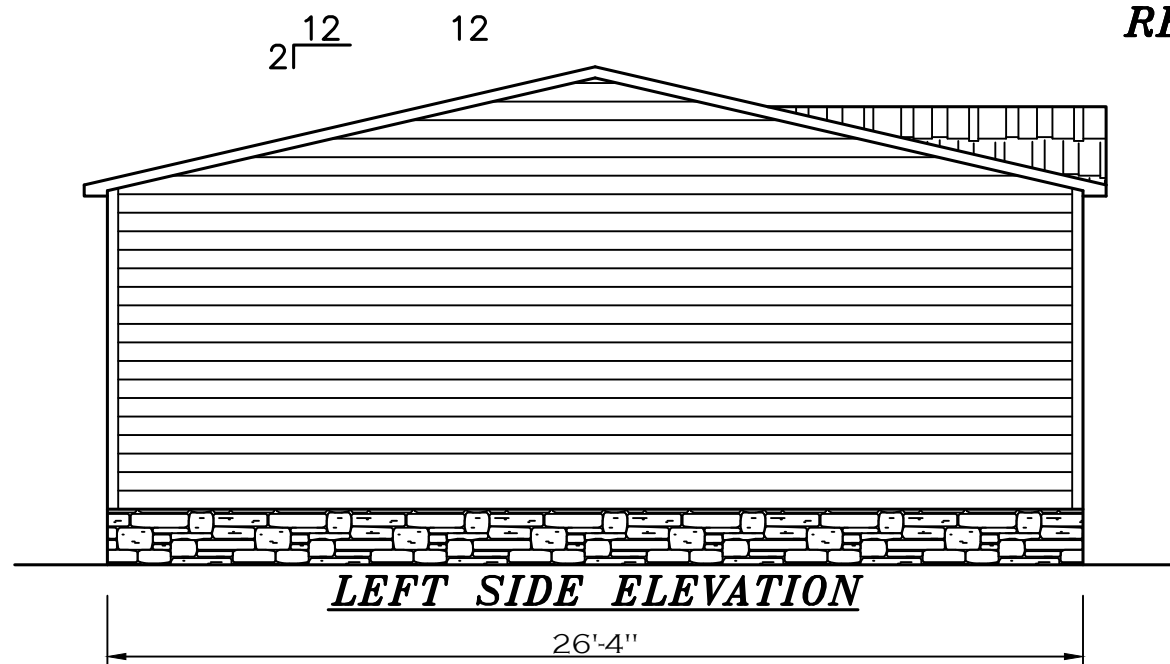

**LEFT SIDE ELEVATION**

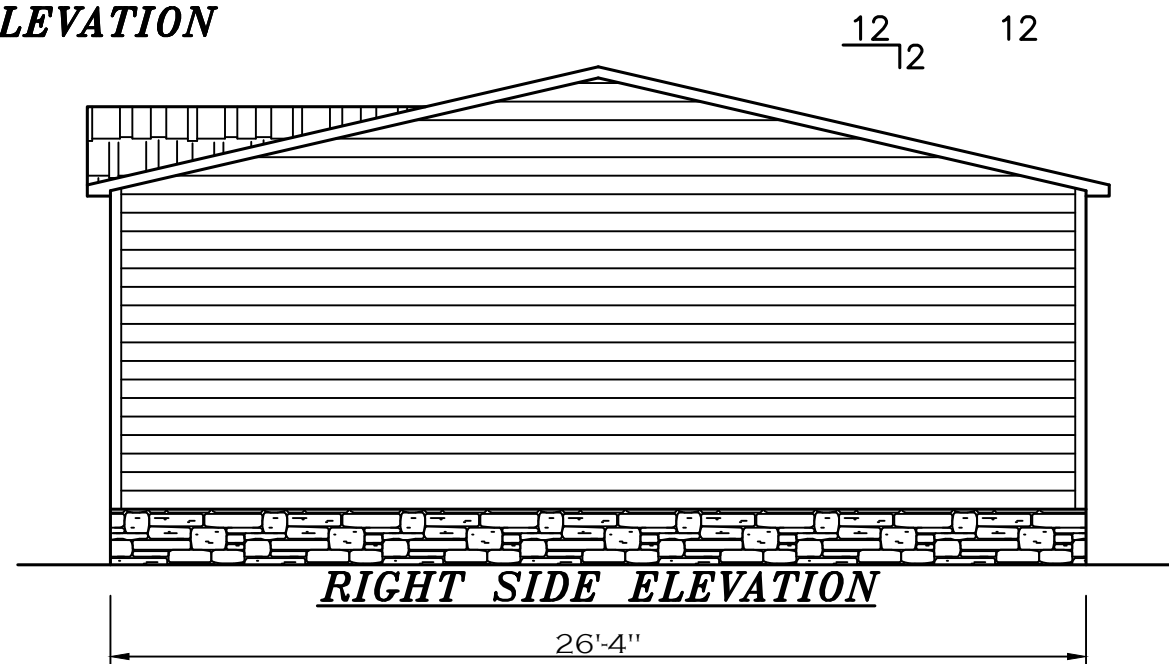

**RIGHT SIDE ELEVATION**



76'-0"  
**FRONT ELEVATION**

REVISION	DATE	DESCRIPTION	REVISION	DATE	DESCRIPTION

SHEET:  
ELEVATION

FRONT

**Clayton** Clayton - 934  
1420 Mountain Rd, Andersonville, TN 37705  
PH: 865.494.7800 FAX: 865.494.0243

HILBORN, WERNER, CARTER,  
AND ASSOCIATES, INC.  
1627 SOUTH MYRTLE AVE.  
CLEARWATER, FL. 33756

DRAWING # 34M213

MODEL # EGL28765A

DATE: 08/1/2023

SCALE: N.T.S.

MODEL: THE EAGLE 76 (28'x76')

SERIES: EAGLE SERIES

PRODUCT DESIGNER: BRIAN RIFFEY

STD PLAN "CONDITIONED": 2,001 FT<sup>2</sup>

REV. BY:

REV. DATE:

- GENERAL NOTES:
- PIER LOADS SHOWN ARE TO BE USED TO SIZE THE FOOTINGS BELOW THE MARRIAGEWALL FOR COLUMN SUPPORT PIERS. REFER TO TABLES 6b AND 6c IN THE INSTALLATION MANUAL FOR LOAD ON FRAME PIER FOOTINGS FOR HOMES THAT DO NOT REQUIRE PERIMETER BLOCKING. REFER TO TABLES 7b AND 7c IN THE INSTALLATION MANUAL FOR LOAD ON FRAME PIER FOOTINGS THAT REQUIRE PERIMETER BLOCKING. REFER TO TABLES 10 AND 10a TO DETERMINE FOOTING SIZE FOR ALL PIERS.
  - REFER TO TABLE 9 FOR PIER CONFIGURATION AND MAXIMUM ALLOWABLE HEIGHTS. CROSS REFERENCE THE PIER HEIGHT WITH THE MAXIMUM ALLOWABLE FLOOR HEIGHT LISTED IN THE FRAME TIEDOWN CHARTS (TABLE 18, 19, AND 20).
  - FLOOR WIDTH SHOWN IS FOR STANDARD PRODUCT ONLY. CONTACT THE MFG PLANT FOR SPECIFICATIONS OF OPTIONS ORDERED.
  - SERVICE DROP LOCATIONS IDENTIFIED ARE APPROXIMATE.
  - THE MAXIMUM SPACING FOR FRAME SUPPORT PIERS FOR 8" I-BEAMS IS 8 FEET, 10" & 12" I-BEAMS ARE 10 FEET.

20 psf Roof Live Load		
Column Pier #	Distance from Hitch	Pier Load (lbs)
1	27.875	2679
2	39.416	2679
3	60.417	1388
4	65.417	1388

SERVICE DROP LEGEND	
	= ELECTRICAL DROP
	= WATER INLET
	= DWV PLUMBING DROP
	= GAS INLET

PIER LEGEND	
	= SUPPORT UNDER MATING OPENING
	= SUPPORT AT MATING COLUMN
	= SUPPORT UNDER MATING WALL
	= PIER PORCH/RECESSED ENTRY
	= PIER MAIN BEAM
	= PIER PERIMETER

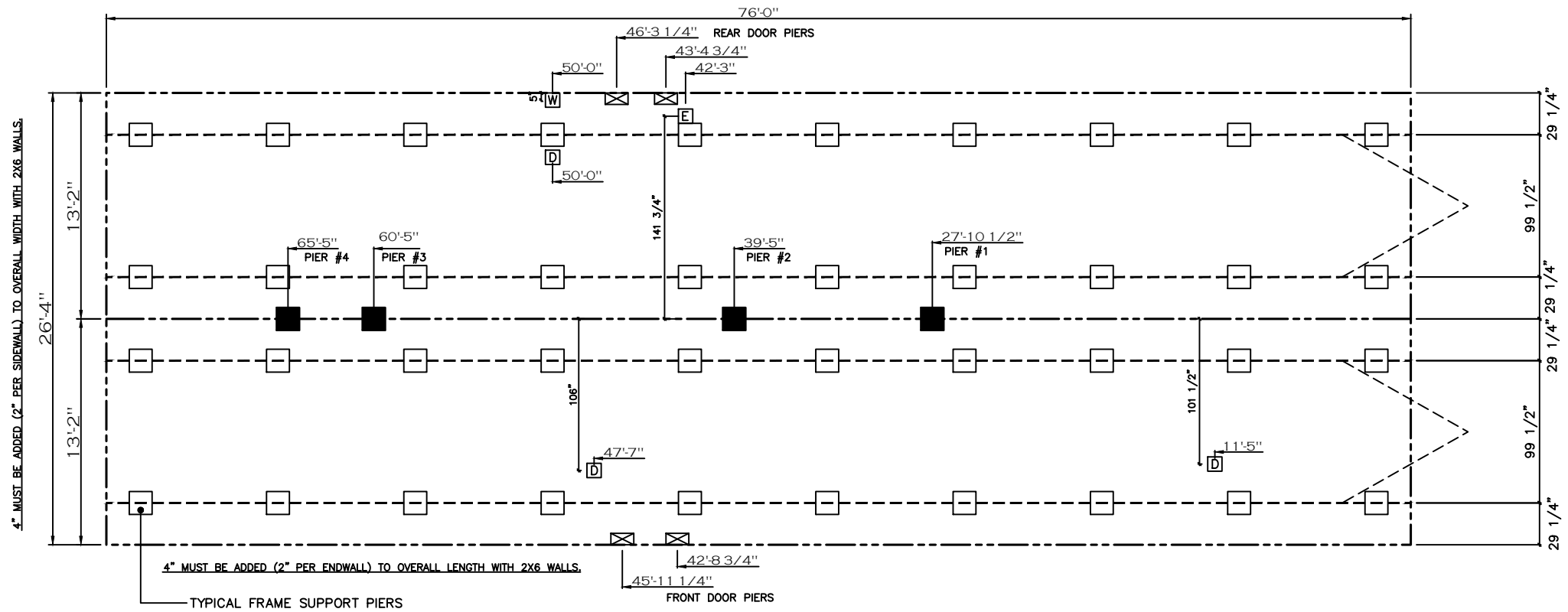

20 lb ROOF LOAD SIDEWALL OPENING PIER LOAD 28' BOX WIDTH	SIDEWALL OPENING (FT) REQUIRED PIER LOAD (LBS)					
	3	4	5	6	8	10
	1162	1315	1467	1620	1925	2230

\*FOR 30 lb & 40 lb ROOF LOAD REFER TO TABLES 7b & 7c IN THE INSTALLATION MANUAL.

REV #	DATE	DESCRIPTION